

Copyright Information

Copyright © 2021 by LAUNCH TECH CO., LTD. All rights reserved. No part of this publication may be reproduced, stored in a retrieval system, or transmitted in any form or by any means, electronic, mechanical, photocopying, recording or otherwise, without the prior written permission of LAUNCH. The information contained herein is designed only for the use of this unit. LAUNCH is not responsible for any use of this information as applied to other units.

Neither LAUNCH nor its affiliates shall be liable to the purchaser of this unit or third parties for damages, losses, costs, or expenses incurred by purchaser or third parties as a result of: Accident, misuse, or abuse of this unit, or unauthorized modifications, repairs, or alterations to this unit, or failure to strictly comply with LAUNCH operating and maintenance instructions. LAUNCH shall not be liable for any damages or problems arising from the use of any options or any consumable products other than those designated as Original LAUNCH Products or LAUNCH Approved Products by LAUNCH.

All information, specifications and illustrations in this manual are based on the latest information available at the time of release. LAUNCH reserves the rights to make changes at any time without notice.

Statement: LAUNCH owns the complete intellectual property rights for the software used by this product. For any reverse engineering or cracking actions against the software, LAUNCH will block the use of this product and reserve the right to pursue their legal liabilities.

Trademark Information

LAUNCH is a registered trademark of LAUNCH TECH CO., LTD. (LAUNCH) in China and other countries. All other LAUNCH trademarks, service marks, domain names, logos, and company names referred to in this manual are either trademarks, registered trademarks, service marks, domain names, logos, company names of or are otherwise the property of LAUNCH or its affiliates. In countries where any of the LAUNCH trademarks, service marks, domain names, logos and company names are not registered, LAUNCH claims other rights associated with unregistered trademarks, service marks, domain names, logos, and company names. Other products or company names referred to in this manual may be trademarks of their respective owners. You may not use any trademark, service mark, domain name, logo, or company name of LAUNCH or any third party without permission from the owner of the applicable trademark, service mark, domain name, logo, or company name. You may contact LAUNCH at www.launchusa.com, or write to [LAUNCH Tech \(USA\), Inc., 1820 S. Milliken Ave. Ontario, CA 91761](mailto:LAUNCH Tech (USA), Inc., 1820 S. Milliken Ave. Ontario, CA 91761), to request written permission to use Materials on this manual for purposes or for all other questions relating to this manual.

Statement: The following trademarks mentioned in this user's guide are only for illustrative purpose, not for commercial use.

The Bluetooth® word mark and logos are registered trademarks owned by the Bluetooth SIG, Inc..

Android is a trademark of Google LLC.

Other trademarks and trade names are those of their respective owners.

Important Safety Precautions

Important: To avoid personal injury, property damage, or accidental damage to the product, read all of the information in this section before using the product.

- Never collide, throw, or puncture the tool, and avoid falling, extruding and bending it.
- Do not insert foreign objects into or place heavy objects on your device. Sensitive components inside might cause damage.
- Do not use the tool in exceptionally cold or hot, dusty, damp or dry environments.
- This tool is a sealed unit. There are no end-user serviceable parts inside. All internal repairs must be done by an authorized repair facility or qualified technician. If there is any inquiry, please contact the dealer.
- Keep the tool far away from magnetic devices because its radiations can damage the screen and erase the data stored on the tool.
- **DANGER:** Do not attempt to replace the internal rechargeable lithium battery. Contact the dealer for factory replacement.
- **CAUTION:** Please use the included battery and charger. Risk of explosion if the battery is replaced with an incorrect type.
- Do not delete unknown files or change the name of files or directories that were not created by you, otherwise your software might fail to work.

Precautions on Using This Tool

Before using this test equipment, please read the following safety information carefully.

- Always perform automotive testing in a safe environment.
- If the diagnostic connector remains unused for a long period of time, it is suggested to unplug the connector from vehicle's DLC to conserve battery power.
- Wear an ANSI-approved eye shield when testing or repairing vehicles.
- The vehicle shall be tested in a well-ventilated work area, as engines produce various poisonous compounds (hydrocarbon, carbon monoxide, nitrogen oxides, etc.)
- Do not connect or disconnect any test equipment while the ignition is on or the engine is running.
- Put blocks in front of the drive wheels and never leave the vehicle unattended while testing.
- Keep the test equipment dry, clean, free from oil, water or grease. Use a mild detergent on a clean cloth to clear the outside of the equipment as necessary.
- Do not drive the vehicle and operate the test equipment at the same time. Any distraction may cause an accident.

- Keep clothing, hair, hands, tools, test equipment, etc. away from all moving or hot engine parts.
- Before starting the engine, put the gear lever in the Neutral position (for manual transmission) or in the Park (for automatic transmission) position to avoid injury.
- To avoid damaging the test equipment or generating false data, please make sure the vehicle battery is fully charged and the connection to the vehicle DLC (Data Link Connector) is clear and secure.
- Automotive batteries contain sulfuric acid that is harmful to skin. In operation, direct contact with the automotive batteries should be avoided. Keep the ignition sources away from the battery at all times.

Precautions on Operating Vehicle's ECU

- Do not disconnect battery or any wiring cables in the vehicle when the ignition switch is on, as this could avoid damage to the sensors or the ECU.
- Do not place any magnetic objects near the ECU. Disconnect the power supply to the ECU before performing any welding operations on the vehicle.
- Use extreme caution when performing any operations near the ECU or sensors. Ground yourself when you disassemble PROM, otherwise ECU and sensors can be damaged by static electricity.
- When reconnecting the ECU harness connector, be sure it is attached firmly, otherwise electronic elements, such as ICs inside the ECU, can be damaged.

TABLE OF CONTENTS

1 INTRODUCTION 1

 1.1 PACKAGE LIST 1

 1.2 PRODUCT PROFILE 3

2 COMPONENTS & CONTROLS 5

 2.1 DISPLAY TABLET 5

 2.2.1 Front & side views 5

 2.2.2 Rear view 7

 2.2 SMARTLINK DEVICE 7

 2.3 TECHNICAL SPECIFICATIONS 8

 2.3.1 Display tablet 8

 2.3.2 SmartLink device 9

3 PREPARATIONS 10

 3.1 CHARGING THE TABLET 10

 3.3 POWER ON/OFF 10

 3.3.1 Power on 10

 3.3.2 Power off 10

 3.4 SCREEN LAYOUT 10

 3.5 ADJUST BRIGHTNESS 11

 3.6 SET STANDBY TIME 11

 3.7 CHANGING LANGUAGE 11

 3.8 WI-FI SETUP 11

 3.8.1 Connect to a Wi-Fi network 12

 3.8.2 Disconnect from a Wi-Fi network 12

4 INITIAL USE 13

 4.1 GETTING STARTED 13

 4.2 REGISTER & DOWNLOAD DIAGNOSTIC SOFTWARE 13

 4.3 FUNCTION MODULES 15

 4.4 VEHICLE MENU LAYOUT 17

 4.5 CONNECTIONS 19

 4.5.1 Preparation 19

 4.5.2 DLC location 19

 4.5.3 Vehicle connection (For Passenger Vehicles) 19

 4.5.3 Vehicle connection (For Commercial Vehicles) 20





4.6 COMMUNICATION SETUP	21
5 DIAGNOSIS	22
5.1 INTELLIGENT DIAGNOSIS (AUTODETECT)	22
5.2 MANUAL DIAGNOSIS.....	25
5.3 TECH 2 TECH (REMOTE DIAGNOSIS).....	36
5.3.1 Interface Layout.....	36
5.3.2 Add Friends	37
5.3.3 Start Instant Messaging	38
5.3.4 Launch Remote Diagnosis (Device-To-Device).....	39
5.3.5 Launch Remote Diagnosis (Device-To-PC)	41
5.4 MANAGE REPORTS	43
5.4.1 Health reports	44
5.4.2 Remote reports	44
5.4.3 ROXIE reports	44
5.4.4 Recorded data	44
5.5 I/M READINESS.....	45
5.6 HOW TO VIEW DIAGNOSTIC HISTORY?	46
5.7 DIAGNOSTIC FEEDBACK	47
5.8 REPAIR INFO	47
6 SOFTWARE UPDATE.....	49
6.1 UPDATE DIAGNOSTIC SOFTWARE & APP	49
6.2 UPDATE FREQUENTLY USED SOFTWARE.....	50
6.3 RENEW SOFTWARE SUBSCRIPTION.....	50
7 SETTINGS	52
7.1 GENERAL	52
7.1.1 Units	52
7.1.2 Expiration reminder	52
7.1.3 Identifix settings	52
7.1.4 Diagnostic software auto update.....	52
7.1.5 Diagnostic application auto update	52
7.2 VCI.....	53
7.3 ROXIE MANAGEMENT	53
7.4 SHOP INFORMATION.....	54
7.5 PROFILE	54
7.6 UPGRADE PERIOD	54







7.7 DISPLAY	54
7.7.1 Icon size	54
7.7.2 Color theme	54
7.8 SUBSCRIPTION RENEWAL CARD	54
7.9 PRINTER SET	55
7.10 DATA STREAM SAMPLE	57
7.11 SOFTWARE CUSTOMIZATION	57
7.12 BACKUP/RESTORE	58
7.13 CHANGE PASSWORD.....	59
7.14 CLEAR CACHE	59
7.15 ABOUT	59
7.16 LOG OUT.....	59
8 TOOLBOX	60
8.1 TPMS	60
8.2 ADAS	60
8.3 VIDEOSCOPE	62
8.4 OSCILLOSCOPE	62
8.5 IGNITION SCOPE	63
8.6 SENSOR SIMULATOR.....	63
8.7 MULTIMETER	63
8.8 BATTERY TESTER	64
9 OTHERS	65
9.1 WIRELESS UPGRADE	65
9.2 FILE MANAGER	66
9.3 SYSTEM SETTING	67
10 J2534 REPROGRAMMING USING SMARTLINK	68
10.1 AS A LOCAL J2534 PASSTHRU DEVICE	68
10.2 AS A REMOTE J2534 PASSTHRU DEVICE	68
11 FAQ.....	70
12 GLOSSARY OF TERMS & ABBREVIATIONS.....	72

1 Introduction

1.1 Package List

For different product configurations, the accessories may vary. For detailed accessory items, please consult from the local agency or check the package list supplied with the tool together.

No.	Item	Descriptions	Qt.
1	Display tablet	 Indicates the test result.	1
2	SmartLink device	 Collects the vehicle data and sends it to the tablet for analysis.	1
3	Power adaptor	 To charge the tablet.	1
4	Type A to Type B data cable	 Connects the tablet to the SmartLink device or add-on module (such as Scope Box).	1

5	Type A to Type C USB cable	 <p>Connects the tablet to the PC for data exchange.</p>	1
6	HDMI cable	 <p>To mirror the tablet screen onto an external projector or monitor with HD interface.</p>	1
7	OBD I Adapter Cable	 <p>An adapter cable for connecting non-16 pin connector.</p>	1
8	Cigarette Lighter Cable	 <p>To supply power to the non-16pin connector via vehicle's cigarette lighter receptacle.</p>	1
9	Battery Clamps Cable	 <p>To supply power to the non-16pin connector via vehicle's battery.</p>	1
10	Private & Confidential Paper	 <p>A piece of paper bearing Product S/N and Verification Code, which is required for your VCI activation.</p>	1

11	Non-16pin adaptor cable kit	To connect to the vehicle equipped with non-OBD II management system.	(Optional)
12	O2-1 Scope Box Kit	 <p>For detailed accessories, please check the package box</p>	1

1.2 Product Profile

X-431 Throttle III is an evolutionary smart solution for professional automotive diagnostics and maintenance. This Android OS-based, tablet-style scanner incorporates the best possible coverage of OE-level diagnostics with multitasking capable software. It inherits from LAUNCH's advanced diagnosing technology and is characterized by covering a wide range of vehicles, featuring powerful functions, and providing precise test result.

Using the powerful Octa-core 2GHz processor, 8G RAM, and a 13.3" IPS capacitive touch screen with a resolution of 1920 x 1080 dots, it delivers quick and complete diagnostic functionalities which technicians need to diagnose, research and repair vehicles in one solution.

It supports the following functions:

- **Smart Diagnosis (AutoDetect):** This module allows you to use the VIN information of the currently identified vehicle to access its data (including vehicle information, historical diagnostic records) from the cloud server to perform quick test.
- **Local Diagnosis:** To perform diagnosis by executing on-screen commands step by step. Diagnosis functions include: Read DTCs, Clear DTCs, Read Data Stream, Special Functions etc.
- **I/M Readiness:** I/M refers to Inspection and Maintenance that is legislated by the Government to meet federal clean-air standards. I/M Readiness indicates whether or not the various emissions-related systems on the vehicle are operating properly and are ready for Inspection and Maintenance testing.
- **Tech-To-Tech:** This option aims to help repair shops or technicians launch instant messaging and remote diagnosis, making the repair job getting fixed faster.
- **Maintenance & Reset:** All kinds of common maintenance and reset items including Oil lamp reset, DPF regeneration, ABS bleeding etc. can be done.
- **Diagnostic History:** Provides a quick access to the tested vehicles and users can choose to view the test report or resume from previous diagnostic session, without the

necessity of starting from scratch.

- Pre- and Post- Repair Result Comparison: By comparing the pre-repair and post-repair report, you can clearly determine which vehicle issues have been fixed and which remained unsolved.
- One-click Update: Lets you update your diagnostic software online.
- Diagnostic feedback: Enables you to submit the vehicle issue to us for analysis and troubleshooting.
- Repair Info: Multiple speed dial to professional repair website are available for helping repair professionals diagnose and repair vehicle efficiently, accurately and profitably.
- Vehicle Coverage: Enables you to quickly check which vehicle models are supported.
- Backup/Restore: This feature lets you back up the recorded files to external storage device/restore the recorded data from external storage device.
- Add-on Modules: Scopebox, Sensorbox, Batterybox and Videoscope (sold separately) are available for extending the functions of the tool.

2 Components & Controls

There are three main components to the X-431 Throttle III system:

- Display tablet – the central processor and monitor for the system (See Chapter 2.1)



- SmartLink device – the VCI (Vehicle Communication Interface) device for accessing vehicle data (See Chapter 2.2)



2.1 Display tablet

The tablet acts as the central processing system, which is used to receive and analyze the live vehicle data from the SmartLink device and then output the test result.

2.2.1 Front & side views

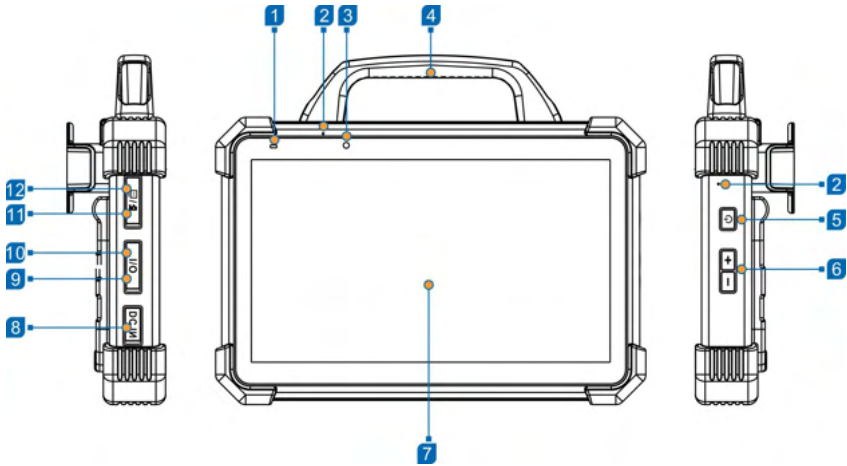

The following table formulates ports and indicators of display tablet:

1	Charging indicator	It illuminates red while the tablet is charging. Once charging is finished, it will illuminate solid green.
2	Microphone	
3	Front Camera	
4	Handgrip	
5	Power/Screen Lock Button	To turn the tablet on/off with long press, or lock the screen with short press.
6	Volume Buttons	To adjust the volume.
7	Display Screen	
8	DC-IN Port	Connects the power adapter to charge the tablet.
9	Type-C Data Transmission Port	Connects it to the PC for data exchange.
10	Type-A Port	Reserved for add-on modules (such as Oscilloscope, Ignition, Sensor, Multimeter etc), and other devices with similar port.
11	Memory Card Slot	Stores the memory card for storage expansion.
	SIM Card Slot	Disabled for this edition.

- | | | |
|----|---|---|
| 12 | High Definition Multimedia Output Port | Connects it to an external projector or monitor with similar interface. |
|----|---|---|

2.2.2 Rear view

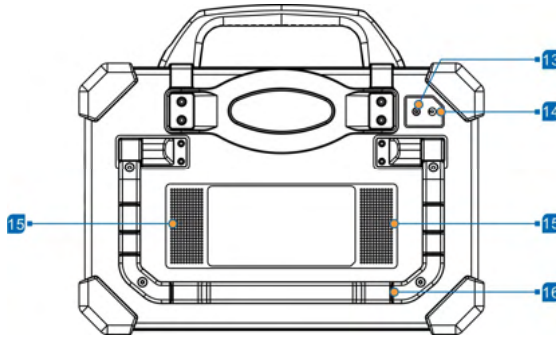

- | | | |
|----|-----------------------------|---|
| 13 | Rear Camera | |
| 14 | Camera Flash | It illuminates red while the tablet is charging. Once charging is finished, it will illuminate solid green. |
| 15 | Audio Speaker | |
| 16 | Adjustable Kickstand | Flip out it to any angle and work comfortable at your desk, or hang it on automotive part. |

2.2 SmartLink Device

The SmartLink device features powerful functions and it can be applied in the following situations:

1. When as a **VCI (Vehicle Communication Interface) device**, it needs to work in conjunction with the Diagnose module of the tablet, which is used to obtain vehicle data, and then send it to the tablet for analysis via Wi-Fi / Bluetooth / USB cable.
2. When as a **local or remote J2534 PassThru device**, it can be used in conjunction with the PC installed with OEM diagnostic software.

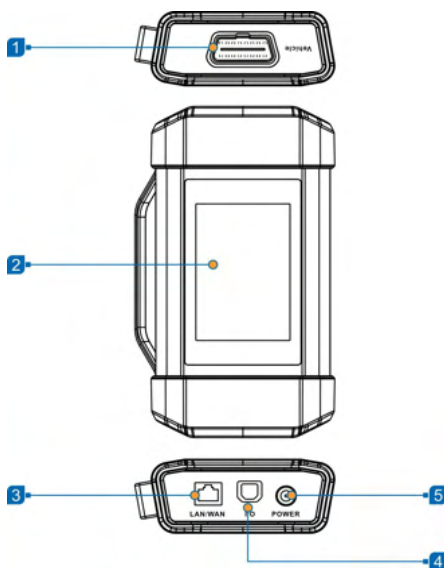

1	OBD-16 Diagnostic Connector	Connects the SmartLink device to the vehicle's DLC (Data Link Connector) port via the OBD II extension cable.
2	Display Screen	
3	LAN/WAN Port	Connects the SmartLink device to the Internet via the crossover cable.
4	Data I/O Port	Connects the SmartLink device to the PC via the data cable when as a J2534 PassThru device.
5	DC-IN Port	Currently disabled and for manufacturer use only. *Warning: The SmartLink device obtains power through the vehicle's DLC, and it is prohibited to connect to an external DC power supply. No responsibility can be assumed for any damage or loss caused as a result of not strictly following the above method.

2.3 Technical Specifications

2.3.1 Display tablet

Operating system Android 9

Processor	Octa-core processor, 2GHz
Display	13.3 inch IPS capacitive touch screen with 1920 x 1080 resolution
Memory	8GB
Storage	256GB
Connectivity	<ul style="list-style-type: none"> • Wi-Fi: 2.4G/5GHz dual frequency • Universal serial BUS Ports (1 x Type-C + 1 x Type-A)
Camera	13MP rear-facing camera (Auto focus)
HDMI	MicroHDMI out
Speaker	Two 1.5W speakers
Microphone	Two microphones
Working temperature	-10°C ~ 50°C(14 ~122°F)
Storage temperature	-20°C ~ 70°C(-4 ~158°F)

2.3.2 SmartLink device

Working voltage	DC 9 ~36V
Size	204mm x 110mm x 45mm
Standby current	About 50mA
Typical power consumption	≤ 6W
Communication via	Bluetooth, Wi-Fi or data cable connection
Operating Temperature	-10°C ~ 50°C(14 ~122°F)

3 Preparations

3.1 Charging the Tablet

Connect one end of the power adaptor to DC-IN port of the tablet, and the other end to the AC outlet. The charging LED illuminates solid red while charging. Once it illuminates solid green, it indicates that the battery is fully charged. Disconnect the power adaptor from the AC outlet.

*Note: If the battery remains unused for a long period of time or the battery is completely discharged, it is normal that the tool will not power on while being charged. Please charge it for a period of 5 minutes and then turn it on.

*Warnings:

- Only use the included power adapter to recharge the tablet. Use of any other adaptor will damage the tool. We assume no responsibility for damage or loss resulting from using other similar adaptors other than the specified one.
- Always charge on a non-flammable surface in a well-ventilated area.

3.3 Power on/off

3.3.1 Power on

Press and hold the POWER button for about 3 seconds to turn on the tablet. The system starts initializing and then enters the Home screen.

*Note: If it is the first time you have used this tool or the tool remains idle for a long period of time, the tool could fail to turn on. Please charge the tool for a minimum of 5 minutes and attempt to turn on again.



3.3.2 Power off



To turn the tablet off, press and hold the POWER button until an option menu appears. Tap **Power Off**.

3.4 Screen Layout



There are 6 on-screen buttons available on the bottom of the screen.

-  **Back:** Tap it to return to the previous screen.
-  **Home:** Tap it to navigate to the Android's home screen.
-  **Recent App:** Tap it to view the recently launched applications and running applications.

-  **VCI Connection:** Shows whether the VCI device is properly connected or not.
-  **Screenshot:** Tap it to capture the current screen.
-  **App Setting :** Tap it to enter the app setting screen.

3.5 Adjust Brightness

*Tips: Reducing the brightness of the screen is helpful to save the power of the tablet.

1. On the home screen, tap **Settings -> Display -> Brightness level**.
2. Drag the slider to adjust it.

3.6 Set Standby Time

If no activities are made within the defined standby period, the screen will be locked automatically and the system enters sleep mode to save power.

1. On the home screen, tap **Settings -> Display -> Advanced -> Sleep**.
2. Choose the desired sleep time.

3.7 Changing Language

The tablet supports multiple languages. To change the language of the tablet, please do the following:

1. On the home screen, tap **Settings -> Language & Input -> Languages**.
2. Tap **Add a language**, and then choose the desired language from the list.
3. Tap and hold the desired language and drag it to the top of the screen and then release it, the system will change into the target language.

3.8 Wi-Fi Setup

*Note: Once WLAN is set as ON, the tablet will consume more power. While WLAN keeps unused, please turn it off to conserve battery power.

The tablet has dual built-in Wi-Fi communication modules. One is used to communicate with the tablet, and the other allows the tablet to get online. Once you're online, you can register your tool, update diagnostic software & APK, browse the Internet and send email on your network.

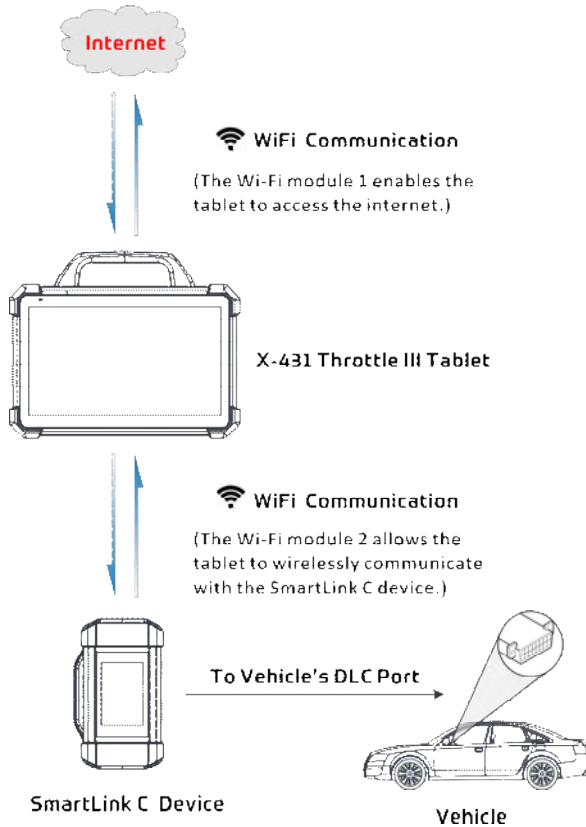

If the SmartLink device is successfully activated, it will be automatically bound to the tablet. In this case it is not necessary for the user to manually configure it again.

3.8.1 Connect to a Wi-Fi network

1. On the home screen, tap **Settings -> Network & internet -> Wi-Fi**.
2. Tap or slide the Wi-Fi switch to ON, the tablet starts searching for all available wireless LANs.
3. Select the desired Wi-Fi access point / network from the list. If the chosen network is open, you can connect directly. A password may be required for secured networks.

3.8.2 Disconnect from a Wi-Fi network

1. On the home screen, tap **Settings -> Network & internet -> Wi-Fi**.
2. Tap the network with a **Connected** status, then tap **Forget**.

4 Initial Use

4.1 Getting Started

For new users, please follow the operation chart shown below to get started with this tool.

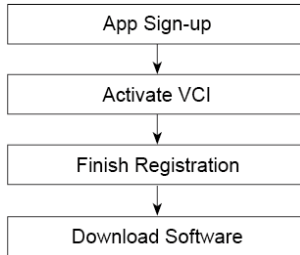

4.2 Register & Download Diagnostic Software

On the home screen, tap the application icon to launch it, the following dialog box will pop up on the screen:

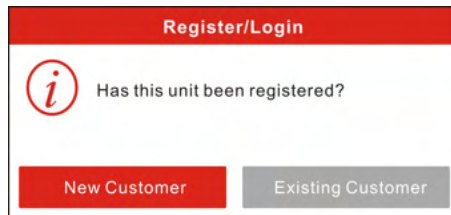

A. If you are a new user, tap **New Customer** to start your sign-up.

a) Create App Account: Fill in the information in each field (Items with * must be filled).

After inputting, tap **Register**, the following screen will appear:

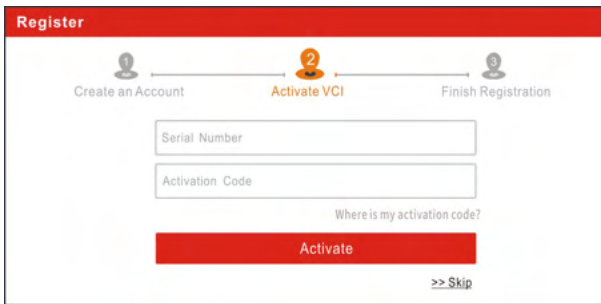

b) Activate VCI: Input the Serial Number and Activation Code, which can be found in the password envelope.

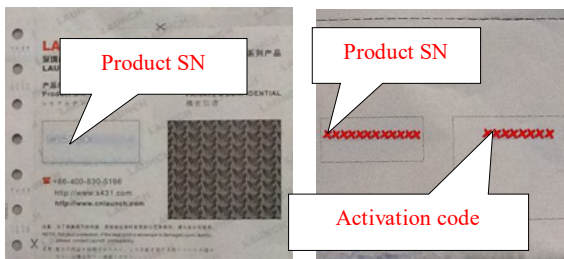

*Note: To exit and activate it later, tap **Skip**. In this case, you can activate it by tapping **Activate VCI** in **Settings -> VCI**.

Tap **Activate** to finish your registration.

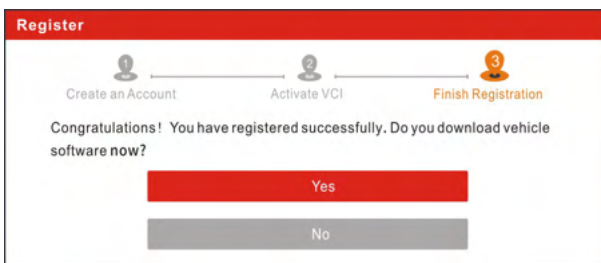

c) Finish Registration: To download the diagnostic software, tap **Yes** to navigate to the download page. Tap **No** to download and install it later.

On the download page, tap **Update** to start downloading. To pause downloading, tap **Stop**. Once download is complete, the system will install the software package automatically.

*Note: In process of download, please make sure the tablet has a strong Wi-Fi signal. It may take several minutes to finish it, please be patient to wait.

B. If you have registered to be a member, tap **Existing Customer**, the following screen will appear:

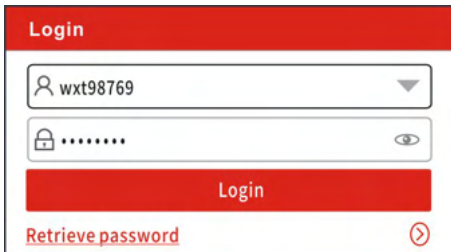

(If you have registered to be a member, go to **a**) to login the system directly.)

(In case you forgot password, refer to **b**) to reset a new password.)

a) If you have registered to be a member, input your name and password, and then tap **Login** to enter the main menu screen directly.

*Note: This tablet has an auto-save function. Once the username and password are correctly entered, the system will automatically store it. Next time you login the system, you will not be asked to input the account manually.

b) If you forgot the password, tap **Retrieve password** and then follow on-screen instructions to set a new password.

4.3 Function Modules

There are two function modules available on the tablet: **Diagnostics**, **Toolbox** and **Others**. Swipe the screen in from left/right to toggle between them.

Diagnostics mainly includes the following items:

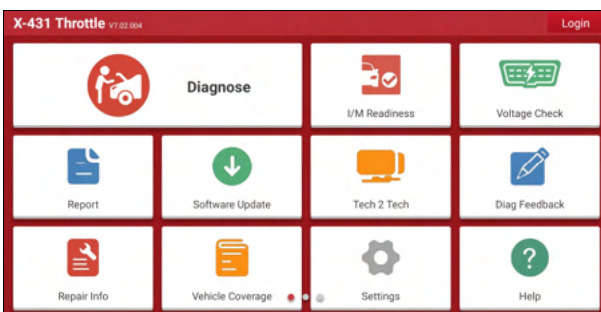

Name	Description
Diagnose	To configures the tablet to operate as a diagnostic tool.
I/M Readiness	I/M Readiness indicates whether or not the various emissions-related systems on the vehicle are operating

	properly and are ready for Inspection and Maintenance testing.
Voltage Check	Performs a check of the vehicle's battery to ensure the system is operating within acceptable limits.
Report	To manage saved diagnostic reports and records.
Software Update	To update vehicle diagnostic software and APK.
Tech 2 Tech	This option aims to help repair shops or technicians launch instant messaging and remote diagnosis, making the repair job getting fixed faster.
Diag. Feedback	To feed back the recent 20 diagnostic logs to us for issue analysis.
Repair Info	Provides quick access to various authorized automotive repair database.
Vehicle Coverage	Views all the vehicle models that the tablet covers.
Settings	Makes some general system settings, VCI management, configure printer and shop information, clear diagnostic software and backup/restore etc.
Help	Includes FAQ, Quick Start Guide and User Manual.

Toolbox mainly includes the following add-on modules:

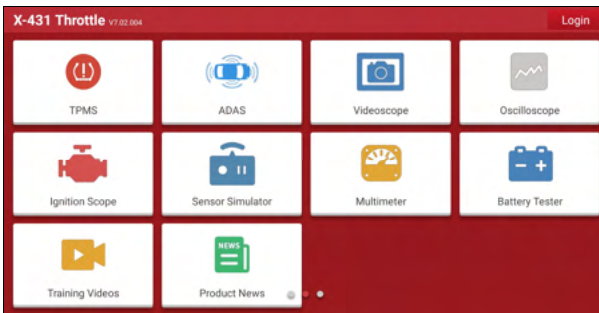

Name	Description
TPMS	This module allows you to configure the tablet as TPMS activation & diagnostic tool, which provides the ability to trigger TPMS sensor, program TPMS sensor, perform the relearning procedure. It needs to work with the X-431 TSGUN device (sold separately).

ADAS	This function enables users to perform ADAS (Advanced Driver Assistance System) calibration operations. The ADAS calibration software is disabled by default. Before using this function, users must activate the ADAS function using the ADAS Activation Card.
Videoscope	To check unseen or unreachable parts or components.
Oscilloscope / Ignition Scope	To determine vehicle electrical equipment and circuit trouble.
Sensor Simulator	To diagnose/simulate vehicle ECU sensor trouble.
Multimeter	To measure physical parameters such as voltage, resistance, frequency etc. *Note: The function utilizes the same hardware device as the sensor module.
Battery Tester	To test whether vehicle's battery is good or not.

Other mainly provides quick access to some system apps, such as camera, gallery, file manager, clock, calendar, wireless upgrade etc.

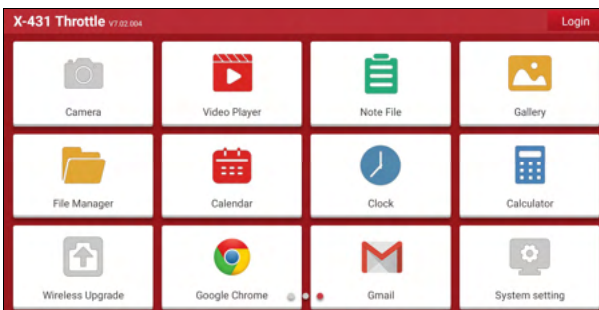

4.4 Vehicle Menu Layout

After downloading the diagnostic software, go to **Diagnose** to check if all software are completely downloaded and installed.

Tap **Diagnose**, the following screen will appear:

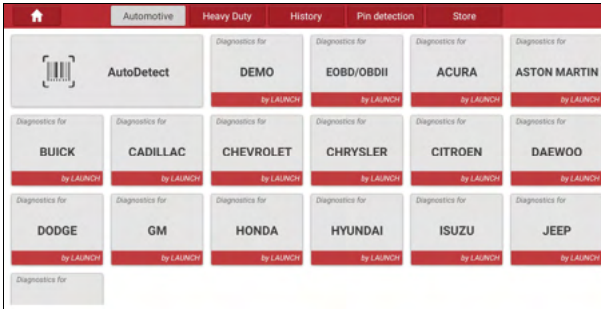

1 **Automotive** Tab: Displays all the passenger vehicle models.

2 **Heavy Duty** Tab: Tap it to select the corresponding heavy-duty vehicle models.

3 **History** (Previous Session): Generally once a vehicle diagnosis is performed, the tablet will record the every details of diagnostic session. The History function provides direct access to the previously tested vehicles and users can resume from the last operation, without the necessity of starting from scratch.

Pin Detection: This module allows you to detect the voltage of the vehicle OBD II diagnostic socket pins and the supported protocol types to help technicians judge the OBD II diagnostic interface.

4

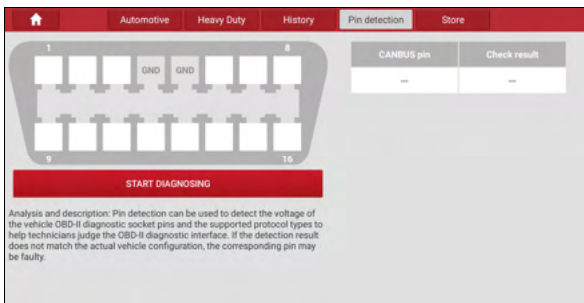

*Note: Before using this function, the SmartLink device should be properly connected to the vehicle's DLC port.

5 **Store:** Allows you to renew the subscription of diagnostic software and check the order status.

6 **AutoDetect:** Through simple Bluetooth communication between the tablet and VCI device, you can easily get the VIN (Vehicle Identification Number) information of the currently identified vehicle. Once the VIN is successfully identified, the system will retrieve it from the remote server and then guide you to vehicle information page without the necessity of step-by-step manual menu

selection.

4.5 Connections

4.5.1 Preparation

Normal testing conditions

- Turn on the vehicle power supply.
- Vehicle battery voltage range should be 11-14V or 18-30V.
- Throttle should be in a closed position.

4.5.2 DLC location

1. For Passenger Vehicles,

The DLC (Data Link Connector) is typically a standard 16 pin connector where diagnostic code readers interface with the vehicle's on-board computer. The DLC is usually located 12 inches from the center of the instrument panel (dash), under or around the driver's side for most vehicles. If Data Link Connector is not located under dashboard, a label should be there telling location. For some Asian and European vehicles, the DLC is located behind the ashtray and the ashtray must be removed to access the connector. If the DLC cannot be found, refer to the vehicle's service manual for the location.

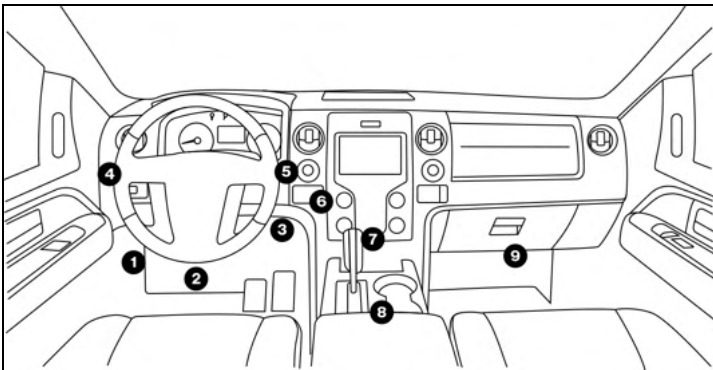

2. For Commercial Vehicles,

The DLC is generally located in driver's cab.

4.5.3 Vehicle connection (For Passenger Vehicles)

The method used to connect the VCI device to a vehicle's DLC depends on the vehicle's configuration as follows:

- A vehicle equipped with an OBD II management system supplies both communication and 12V power through a standardized DLC.
- A vehicle not equipped with an OBD II management system supplies communication through a DLC connection, and in some cases supplies 12V power through the

cigarette lighter receptacle or a connection to the vehicle battery.

For OBD II vehicles, connect the SmartLink to vehicle's DLC directly via the OBD II extension cable.

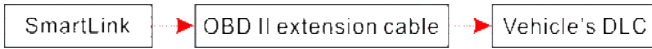

For non-OBDII vehicles, proceed as follows:

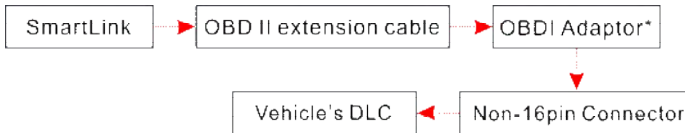

*Note: If the power supply on vehicle diagnostic socket is insufficient or the power pin is damaged, you can get power via either of the following ways:

A. Via Battery clamps cable (optional): Connect one end of the battery clamps cable to the power jack of the OBD I adaptor box, and the other end to the vehicle's battery.

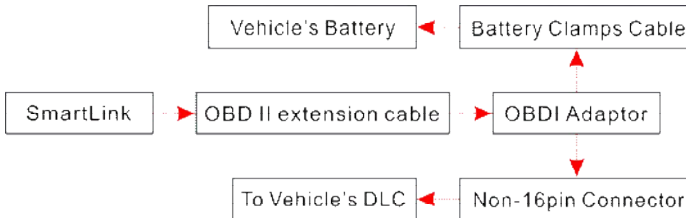

B. Via Cigarette lighter cable (optional): Connect one end of the cigarette lighter cable to the power jack of the OBD I adaptor box, and the other end to the cigarette lighter receptacle.

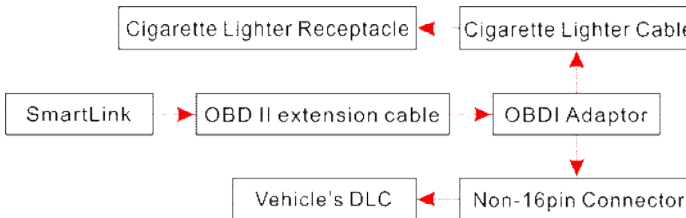

4.5.3 Vehicle connection (For Commercial Vehicles)

The method used to connect the VCI module to a vehicle's DLC depends on the vehicle's configuration as follows:

For OBD II vehicles, connect the SmartLink to vehicle's DLC directly via the OBD II extension cable.

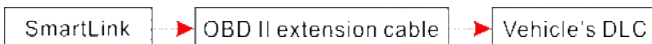

For non-OBDII vehicles, proceed as follows:

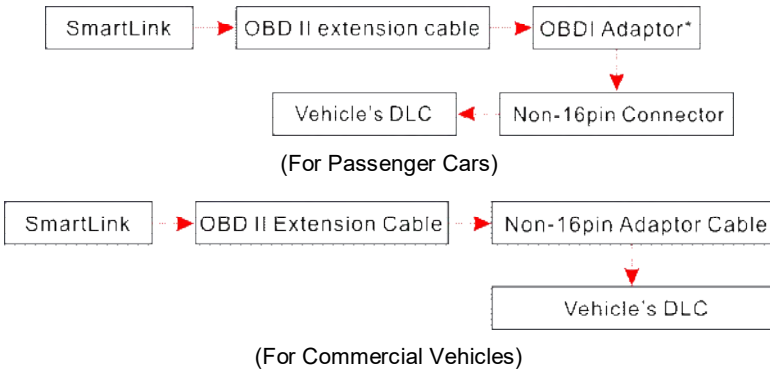

4.6 Communication Setup

There are 3 kinds of ways available for the tablet to communicate with the SmartLink device: Wi-Fi, Bluetooth and USB cable.

After the sign-up is successfully completed, the Wi-Fi communication between the tablet and the SmartLink device is automatically established and user has no need to configure it again.

The Bluetooth communication is inferior to the Wi-Fi communication in transmission speed and stability. This method is not recommended.

The USB cable connection is a simple & quick way to establish communication between the tablet and the SmartLink device.

After properly connecting the SmartLink device to the tablet, the VCI navigation button at the bottom of the screen becomes highlighted indicating the communication is established.

5 Diagnosis

The tablet supports three kinds of diagnosis methods: Smart Diagnosis (AutoDetect), Manual Diagnosis and remote diagnosis (Tech 2 Tech).

5.1 Intelligent Diagnosis (AutoDetect)

Through simple Wi-Fi communication between the tablet and SmartLink device, you can easily get the VIN (Vehicle Identification Number) information of the currently identified vehicle. Once the VIN is successfully identified, the system will retrieve it from the remote server and then guide you to vehicle information page without performing the step-by-step manual menu selection.

The vehicle information page lists all historical diagnostic records of the vehicle, which lets the technician have a total command of the vehicle faults. In addition, a quick dial to local diagnosis and diagnostic function are also available on this page for reducing the roundabout time and increasing productivity.

*Notes:

- Before using this function, please make sure the VCI device is properly connected to the vehicle's DLC. For detailed connection, see Chapter 4.5.3.
- A stable network connection is required for this function.

Follow the steps below to proceed.

1. Tap **Diagnose** on the Diagnostics function selection screen and tap **AutoDetect**.



2. The tablet starts reading the vehicle VIN.

- A. If the VIN can be found from the remote server database, the following screen will appear:

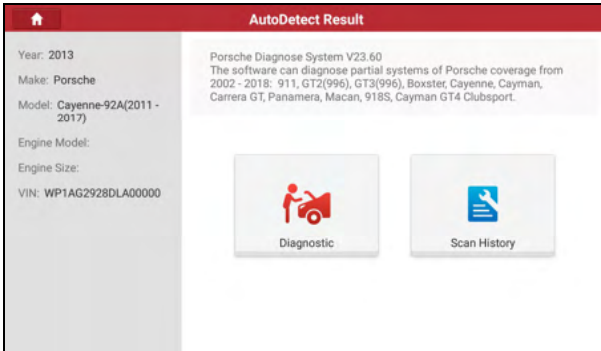



- Tap **Diagnostic** to start a new diagnostic session.
- Tap **Scan History** to view its historical repair record. If there are records available, it will be listed on the screen in sequence of date. If no records exist, the screen will show **No Record**.

Porsche Cayenne-92A(2011 - 2017) 2013 VIN WP1AG2928DLA00000				
2019 11/05	Number of diagnostic systems:27	Quantity of DTCs:21	23:55:48	View Record
2019 10/27	Number of diagnostic systems:27	Quantity of DTCs:21	19:33:07	View Record
	Number of diagnostic systems:27	Quantity of DTCs:21	03:02:48	View Record
2019 10/23	Number of diagnostic systems:27	Quantity of DTCs:21	02:41:38	View Record
				Quick Access

- Tap **View Record** to view the details of the current diagnostic report.
- To perform other functions, tap **Quick Access** to directly go to the function selection screen. Choose the desired one to start a new diagnostic session.

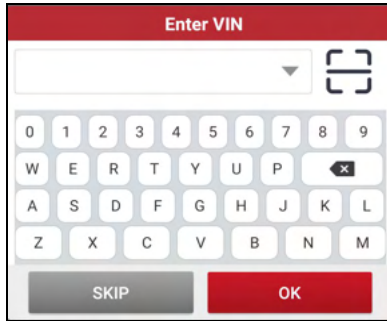
B. If the tablet failed to access the VIN information, the screen will display as below:



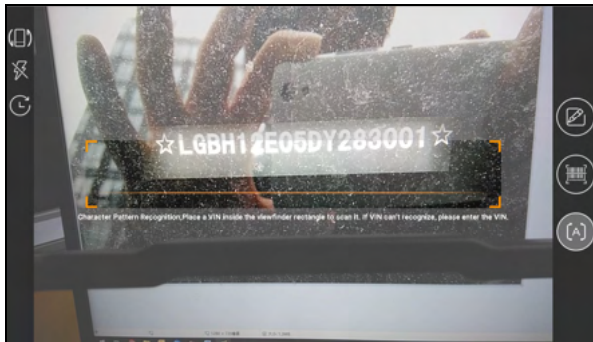

In this mode, you need to input the VIN manually or tap  to scan it.

1) Tap  to launch the VIN recognition module.



Place the VIN inside the viewfinder rectangle to scan it. The most recognizable location for this number is in the top left corner on the vehicle's dashboard. Other locations include the driver's door or post, and the firewall under the hood.

- If you have scanned the VIN of the vehicle, tap  to choose it from the record list.
- In case the tablet failed to detect it, tap  to enter it manually.
- To turn the flash on, tap .

After scanning, the screen automatically displays the result.

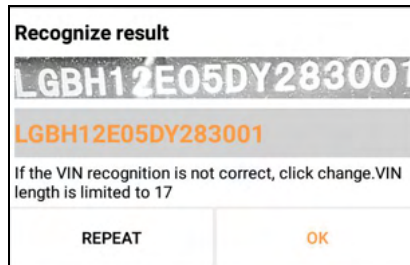

- If the VIN scanned is incorrect, tap the result field to modify it and then tap **OK**. If the VIN exists on the remote server, the system will enter the vehicle information screen.
 - To scan it again, tap **REPEAT**.
- 2) Input the VIN, and tap **OK**, the system will automatically identify the vehicle model and directly navigate to the vehicle information page.

*Note: In general, vehicle identification numbers are standardized - all contain 17 characters. VIN characters may be capital letters A through Z and numbers 1 through 0; however, the letters I, O and Q are never used in order to avoid mistakes of misreading. No signs or spaces are allowed in the VIN.

Tap **SKIP** to go to Diagnostics main menu screen.

5.2 Manual Diagnosis

In this mode, you need to execute the menu-driven command and then follow the on-screen instruction to proceed.

Take **Demo** as an example to demonstrate how to diagnose a vehicle.

- 1). Select diagnostic software version: Tap **DEMO** to go to Step 2. (*Note: If more than one version is available on this tablet, it will be listed on the screen.)

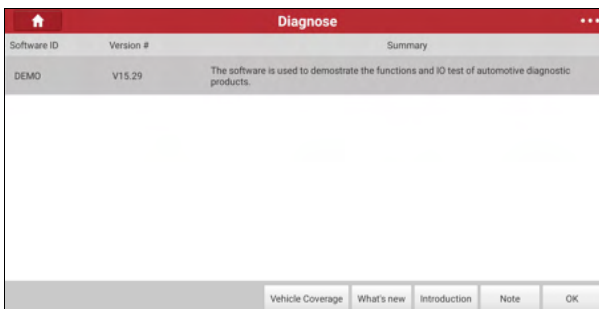

On-screen Buttons:

Vehicle Coverage: Tap to view the vehicle models that the current diagnostic software

covers.

What's new: Tap to view the optimized items and enhancements.

Introduction: Tap to check the software function list.

Note: Tap to read some precautions on using the current diagnostic software.

OK: Tap it to go to next step.

- 2). **Select vehicle model (varies with different versions):** Select the desired vehicle model. Here we take **VW (Volkswagen)** for example.

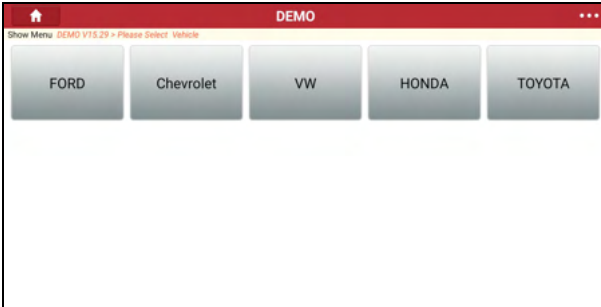

- 3). **Turn the ignition key to ON:** Set the ignition switch to on.

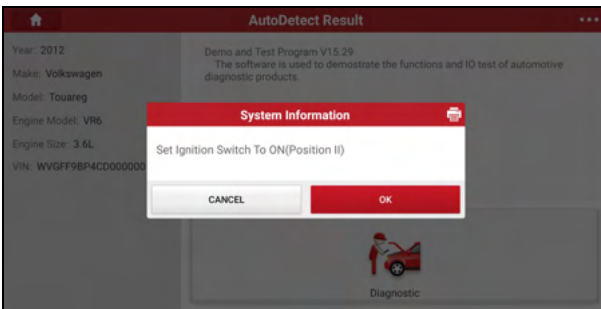

- 4). **Read vehicle information:** After reading the vehicle information, double check if the information is correct or not. If yes, tap **YES** to enter the following screen.

All vehicle systems can be displayed in form of topology or list. By default, all vehicle systems are displayed in form of topology.

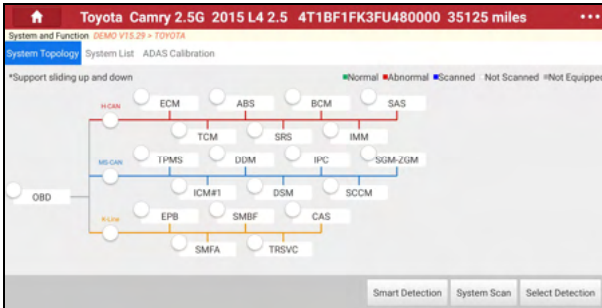

- 1) While in System Topology mode, different highlight bars indicate different detection status.

On-screen Buttons:

Smart Detection: Tap to quickly access all the electronic control units of the vehicle and generate a detailed report about vehicle health. The tested systems malfunctioning are displayed in red with a number indicator displaying DTC quantity and the systems with functioning properly are displayed in green.

*Note: Diagnostic Trouble Codes or Fault Codes can be used to identify which engine systems or components that are malfunctioning. Never replace a part based only on the DTC definition. Retrieving and using DTCs for troubleshooting vehicle operation is only one part of an overall diagnostic strategy. Follow testing procedures (in vehicle’s service manual), instructions and flowcharts to confirm the locations of the problem.

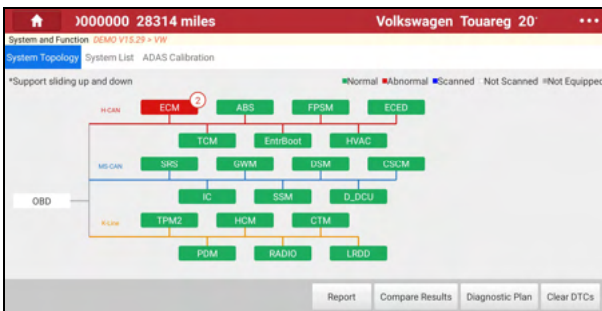

- **Report:** Tap to save the current data in text format.

Choose the report type and input the required information, and then tap **OK**.

*Note: Diagnostic report is classified into two categories: Pre-Repair report and Post-Repair report. To facilitate the comparison of the pre-repair and post-repair reports and get accurate test result, please make sure you saved the right type of the diagnostic report.

Enter the tester and customer name and then tap **OK** to save it. All reports are saved in **Reports -> Health Reports**.

*Note: By default, the workshop information is blank. You can configure and revise it from Settings -> Shop Information. After you configured the information, it will be automatically generated every time the diagnostic report is saved. All vehicle and workshop information will be appended as a tag on the diagnostic report, which allows you to easily retrieve the desired report while performing the Filter function of Diagnostic Report.

- **Compare Results**: Tap to select the pre-repair report to compare. By comparison of the pre- and post- repair reports, you can easily identify which DTCs are cleared and which remain unfixed.

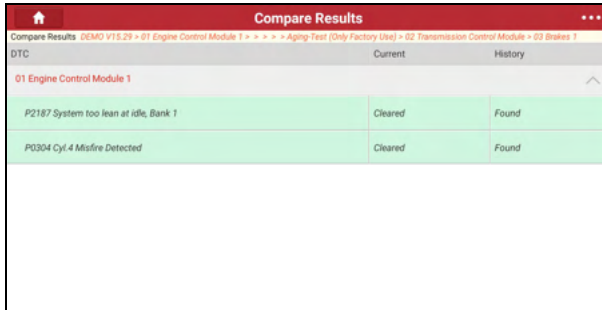

*Note: Before performing this function, please make sure that: 1) You have saved a pre-repair report of the currently tested vehicle; and 2) You have already made some repairs and service and cleared the DTCs after the pre-repair reported is generated. Otherwise, no differences exist between the pre- and post- repair reports.

- **Diagnostic Plan:** Figures out the diagnostic plan and repair solutions for the detected DTCs.

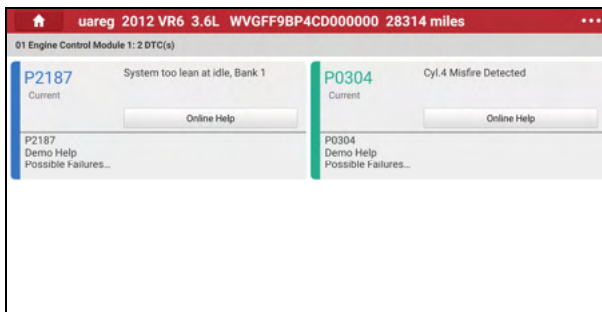

- **Clear DTCs:** Tap to clear the existing diagnostic trouble codes.

*Note: Clearing DTCs does not fix the problem(s) that caused the code(s) to be set. If proper repairs to correct the problem that caused the code(s) to be set are not made, the code(s) will appear again and the check engine light will illuminate as soon as the problem that cause the DTC to set manifests itself.

System Scan: Tap to quickly scan which systems are installed on the vehicle.

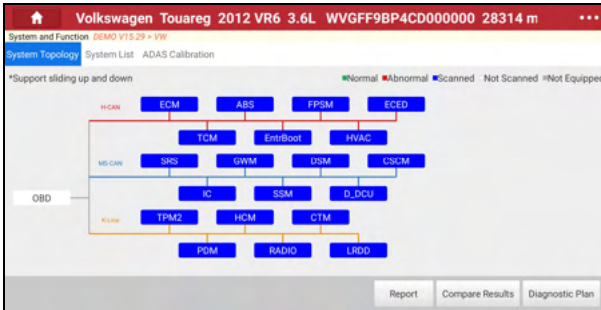

Select Detection: Select certain system and tap it to start scanning the system.

Alternatively user also can tap certain system to manually scan it.

2) While in System List mode, different highlight bars indicate different detection status.

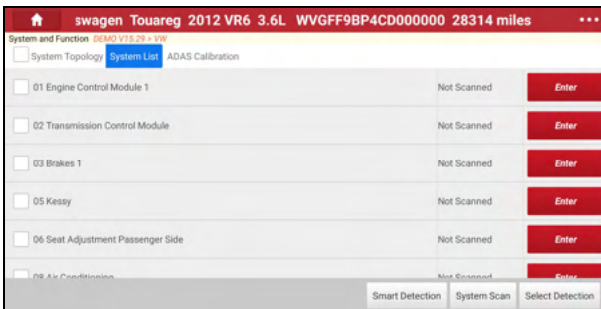

- **Enter:** Select certain system, and tap this button to enter the diagnostic function selection screen.

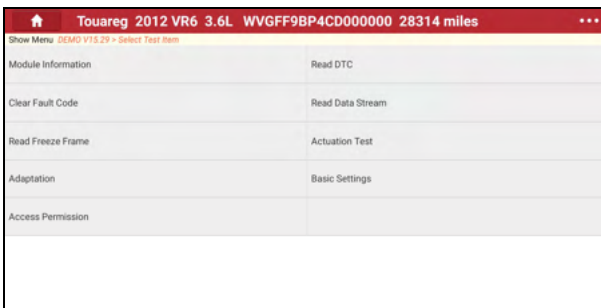

In general, the diagnostic functions vary with different vehicle models. It mainly includes the following options:

A. Module Information

This function is used to read the version information of system mode, vehicle VIN, software and ECU.

B. Read Fault Code

This function displays the detailed information of DTC records retrieved from the vehicle's control system.

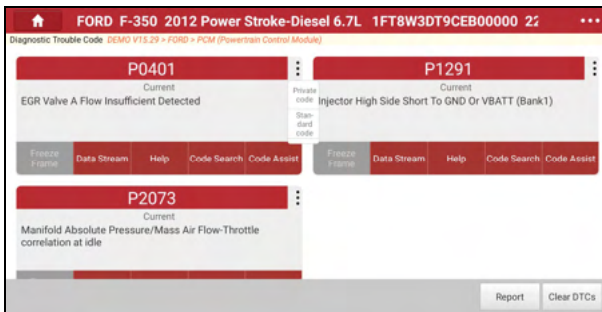

On-screen Buttons:

Freeze Frame: When an emission-related fault occurs, certain vehicle conditions are recorded by the on-board computer. This information is referred to as freeze frame data. Freeze frame data includes a snapshot of critical parameter values at the time the DTC is set.

Help: Tap to view the help information.

Code Search: Tap it to search for more information about the current DTC online.

Code Assist: Tap it to retrieve more information (including code and definition, potential causes and frequent fixes) from the DTC database.

2012 FORD F-350 1FT8W3DT9CEB00000 6.7L Power Stroke-Diesel	
Code and Definition	
P0401	EGR 'A' Flow Insufficient Detected
Top Reported Fix	
Replaced Exhaust Gas Recirculation (EGR) Cooler	
Potential Causes	
Contaminated Intake Air Sensor	
Exhaust Gas Re-Circulation (EGR) Control Valve	
Exhaust Gas Recirculation (EGR) Cooler	
Leaking Exhaust System	
Leaking Turbocharger	
Frequent Fixes	
Cleaned Exhaust Gas Recirculation (EGR) Valve	

Report: To save the current data in text format. All reports are saved in **Report -> Health Reports**.

Clear DTCs: Tap to clear the existing diagnostic trouble codes.

C. Clear Fault Code

After reading the retrieved codes from the vehicle and certain repairs have been carried out, you can use this function to erase the codes from the vehicle. Before performing this

function, please be sure the vehicle's ignition key is in the ON position with the engine off. Clearing DTCs does not fix the problem(s) that caused the code(s) to be set. If proper repairs to correct the problem that caused the code(s) to be set are not made, the code(s) will appear again and the check engine light will illuminate as soon as the problem that cause the DTC to set manifests itself.

*Note: After clearing, you should retrieve trouble codes once more or turn ignition on and retrieve codes again. If there are still some trouble codes in the system, please troubleshoot the code using a factory diagnosis guide, then clear the code and recheck.

D. Read Data Stream

This option lets you view and capture (record) real-time Live Data. This data including current operating status for parameters and/or sensor information can provide insight on overall vehicle performance. It can also be used to guide vehicle repair.

*Note: If you must drive the vehicle in order to perform a troubleshooting procedure, ALWAYS have a second person help you. Trying to drive and operate the diagnostic tool at the same time is dangerous, and could cause a serious traffic accident.

Tap **Read Data Stream**, the following screen will appear:

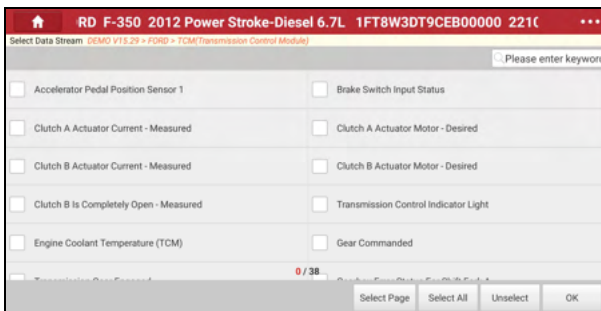

On-screen Buttons:

Select Page: Tap it to select all items of the current page. To select certain data stream item, just check the box before the item name.

Select All: Tap it to select all items.

Unselect: Tap it to deselect all data stream items.

OK: Tap it to confirm and jump to the next step.

After selecting the desired items, tap **OK** to enter the data stream reading page.

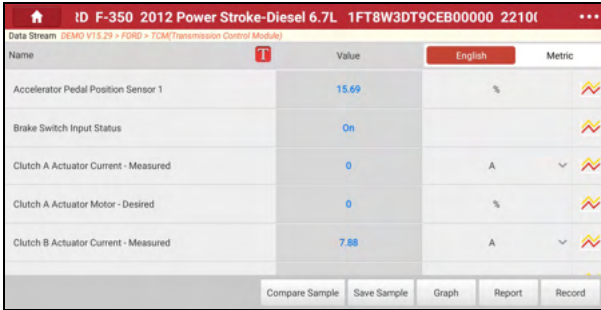

*Notes:

1. Tap **T**, the following popup will appear.

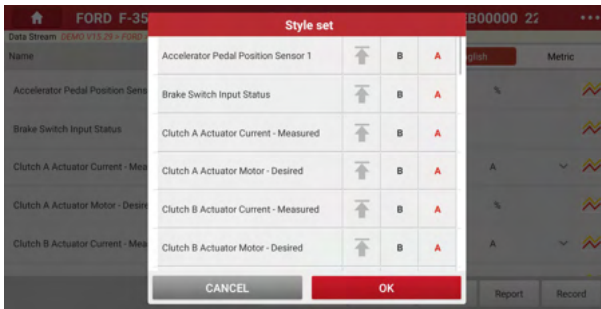

Here the user can set different display style for each selected item.

↑ indicates sticky top. If it is tapped, it will change into **↑**. On the data stream display screen, the data stream item with **↑** will be shown on the top of the selected data stream list. To remove it from the top of the list, just tap it again.

B indicates this item will be displayed in **Bold**.

A indicates this item will be displayed in **Red**.

2. Tap **English** or **Metric** to switch the measurement unit.
3. If the value of the data stream item is out of the range of the standard (reference) value, the whole line will display in red. If it complies with the reference value, it displays in blue (normal mode).
4. The indicator 1/X shown on the bottom of the screen stands for the current page/total page number. Swipe the screen from the right/left to advance/return to the next/previous page.

There are 3 types of display modes available for data viewing, allowing you to view various types of parameters in the most suitable way.

- ✓ Value – this is the default mode which displays the parameters in texts and shows in list format.
- ✓ Graph – displays the parameters in waveform graphs.

- ✓ **Combine** – this option is mostly used in graph merge status for data comparison. In this case, different items are marked in different colors.

On-screen Buttons:

 **(Single graph):** Tap it to view the waveform.

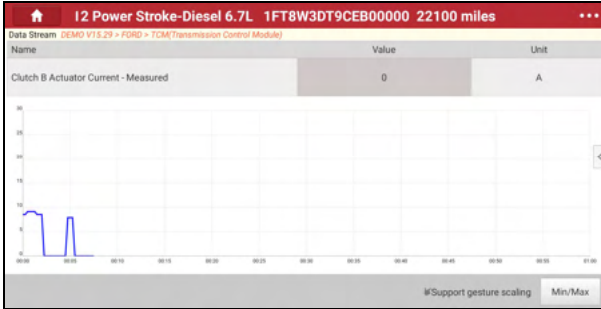

- **Min/Max:** Tap it to define the maximum/minimum value. When the value goes beyond the specified value, the system will alarm.

Graph: Tap it to view the waveform.

- **Combine:** This option is mostly used in graph merge status for data comparison.
- **Value:** Tap to display the parameters in texts.
- **Customize** (): Tap it, a pull-down list of the data stream items appears on the screen. Select/deselect the desired items and then screen will display/remove the waveforms corresponding to these items immediately.

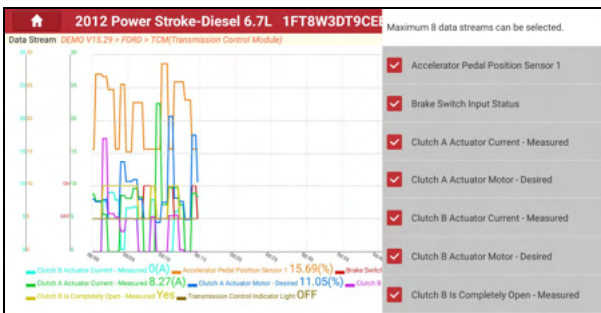

Compare Sample: Tap it to select the sample data stream file, the values you customized and saved in process of data stream sampling will be imported into the **Standard Range** column for your comparison.

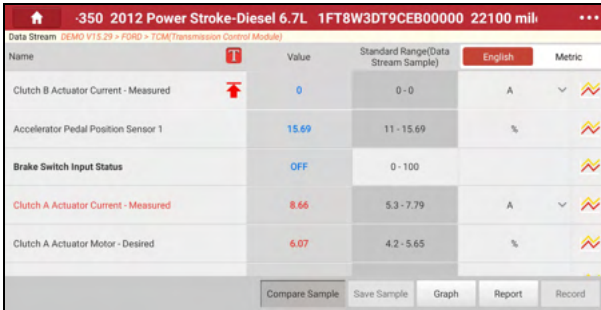

*Note: Before executing this function, you have to sample the values of data stream items and save it as a sample data stream file.

Report: To save the current data in text format. All reports are saved in **Reports -> Health Reports**.

Record: Tap to start recording diagnostic data. Recorded live data can serve as valuable information to help you in troubleshooting of vehicle problems. All recorded files are stored in **Reports -> Recorded Data**.



*Note: The saved file follows the naming rule: It begins with vehicle type, and then the record starting time and ends with .x431 (To differentiate between files, please configure the accurate system time).

Help: Tap to view the help information.

Save Sample: This item enables you to customize the standard range of live data stream items and save it as DS sample file. Each time you run the data stream items, you can call out the corresponding sample data to overwrite the current standard range.

Tap it to start recording the sample data (*Only data stream items with units will be recorded). Once recording is complete, tap  to stop it and navigate to the data modification screen.

Name	Min Value	Max Value	Unit
Accelerator Pedal Position Sensor 1	15.69	28.63	%
Actual Output Shaft Speed	121.5	329.2	rpm
Clutch A Actuator Current - Measured	0.0	22.59	A
Clutch A Actuator Motor - Desired	-1.1	31.3	%
Clutch B Actuator Current - Measured	0.0	8.01	A
Clutch B Actuator Motor - Desired	0.0	5.65	%

Tap the Min./Max. value to change it. After modifying all desired items, tap **Save** to save it as a sample data stream file. All data stream files are stored in **Settings -> Data Stream Sample**.

E. Actuation Test

This option is used to access vehicle-specific subsystem and component tests. Available test vary by vehicle manufacturer, year, and model.

During the actuation test, the tablet outputs commands to the ECU in order to drive the actuators, and then determines the integrity of the system or parts by reading the ECU data, or by monitoring the operation of the actuators, such as switching a injector between two operating states.

5.3 Tech 2 Tech (Remote Diagnosis)

This option aims to help repair shops or technicians launch instant messaging and remote diagnosis, making the repair job getting fixed faster.

Tap **Tech 2 Tech** on the Diagnostics function selection screen, the screen appears blank by default.

5.3.1 Interface Layout

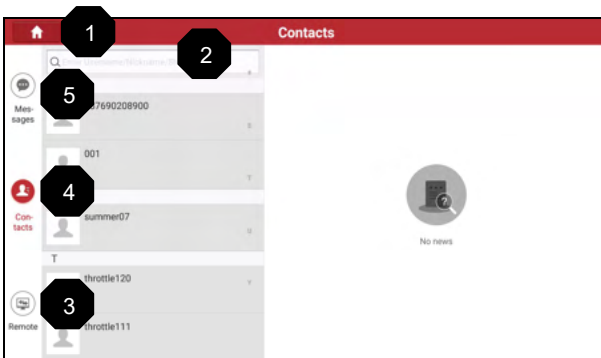

1	Home button	Tap to navigate to the Job menu.
2	Search bar	Directly input the username of the tool to start searching, and then tap the desired one to add it into your friend list.
3	Remote switch	Tap to slide the switch to ON, the tablet keeps online and becomes accessible on the web client. In this case, inform the technician of your product S/N, and he/she will control your device remotely.
4	Contact tab	Tap to enter the friend list. By default it appears blank.
5	Message tab	Once an incoming message reaches, a red dot will appear on the upper right corner of the tab.

5.3.2 Add Friends

Tap **Contacts** to enter the contact page. By default it appears blank.

In the search bar, input the partner’s username and tap **Search** next to the search bar to starts searching from golo business database.

*Note: The partner must be the users who have registered their Launch’s diagnostic tools. They may be the following:

- Workshop
- Technician
- golo users

Once the result matches the keyword, tap the desired one from the search result to enter the instant messaging mode.

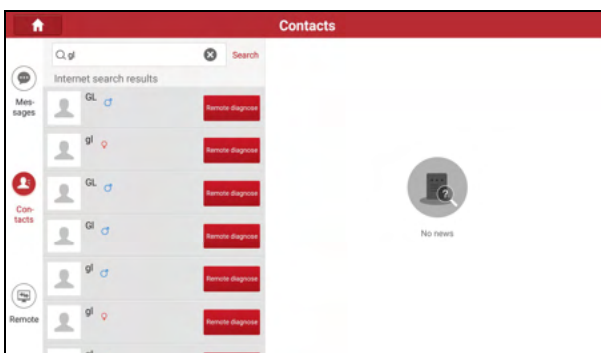

Tap **+** and select Add Friend from the option menu, a dialog box pops up.

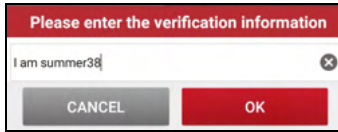

Tap **OK** to send your request.

Once the partner receives the request, a beep will sound. Tap the **Messages** tab:

- Once the partner agreed your request, he/she will automatically be listed in the Contact tab.
- If a technician sent you a friend request, tap **Agree** to confirm and his/her name will appear in the friend list (Contact). Or tap **Ignore** to ignore this request.

5.3.3 Start Instant Messaging

*Note: The I/M (Instant Messaging) function is open to all users who had Launch’s diagnostic tool equipped with this module.

After adding your friends, tap the desired one’s photo to enter the following screen:

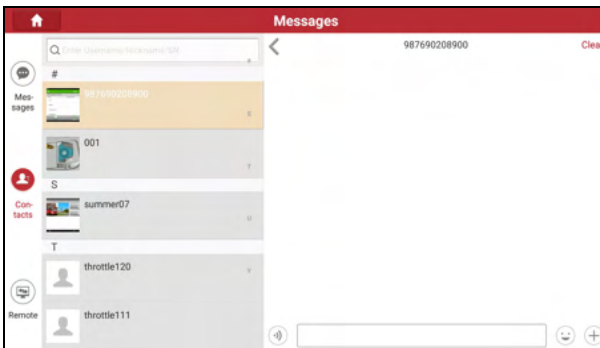

Tap the input field and use the on-screen keyboard to enter the text message, and then tap **Send** to send it.

Tap  to send the voice message.

Tap  to send the emoji.

Tap  to call out more function options.

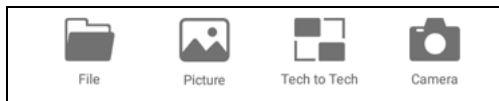

File: Choose diagnostic reports or local files to send.

Picture: Choose screenshots or pictures to send.

Tech 2 Tech: To start a remote diagnostic session. For details, refer to Chapter 5.3.4.

Camera: Open camera to take pictures.

5.3.4 Launch Remote Diagnosis (Device-To-Device)

The tablet is allowed to launch remote diagnosis with other diagnostic tools (including but not limited to the X-431 Throttle III) of Launch family, which are equipped with this module.

*Note: Before performing this operation, please make sure the following no matter which side sends the remote request:

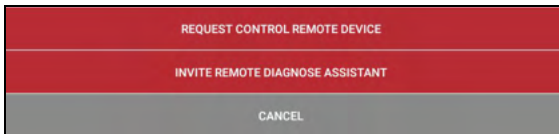

- Turn on the vehicle power supply.
- Throttle should be in a closed position.
- The VCI should be properly connected to the vehicle’s DLC and a successful communication is required.

On the more function selection screen, tap **Tech to Tech**, the following pull-down menu will appear:

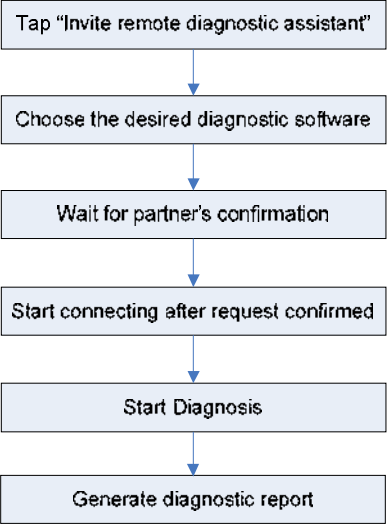

These options are defined as follows:

Actions	Results
Request control remote device	<p>Request to control the partner’s device remotely to help him diagnose the vehicle.</p> <pre> graph TD A[Tap "Request control remote device"] --> B[Wait for partner's confirmation] B --> C[Start connecting after request confirmed] C --> D[Start Diagnosis] D --> E[Generate diagnostic report] </pre> <p>*Notes:</p> <ul style="list-style-type: none"> • Remote diagnosis has the same diagnostic steps as manual diagnosis.

	<ul style="list-style-type: none"> • In process of remote diagnosis, tap the  button to send a voice message. • Once vehicle diagnosis is complete, a report will be created. Input your comments on this report, and then tap Send Report to send it to the partner.
<p>Invite remote diagnostic assistant</p>	<p>If you need support, just use this option to invite a technician to perform a remote control on your tool.</p> <div style="text-align: center;">  <pre> graph TD A[Tap "Invite remote diagnostic assistant"] --> B[Choose the desired diagnostic software] B --> C[Wait for partner's confirmation] C --> D[Start connecting after request confirmed] D --> E[Start Diagnosis] E --> F[Generate diagnostic report] </pre> </div> <p>*Notes:</p> <ul style="list-style-type: none"> • Remote diagnosis has the same diagnostic steps as manual diagnosis. • In process of remote diagnosis, tap the  button to send voice message. • Once you received the report from the partner, tap View Report to view details. All diagnostic reports are saved in Reports -> Remote Reports.

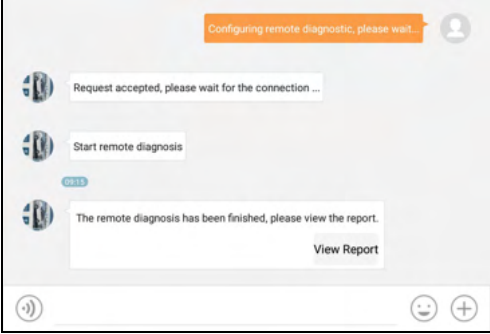
	
Cancel	To cancel this operation.

5.3.5 Launch Remote Diagnosis (Device-To-PC)

Except that the remote diagnosis can be done between different Launch’s diagnostic tools that come loaded with the module, user also can ask for remote control from PC client technician.

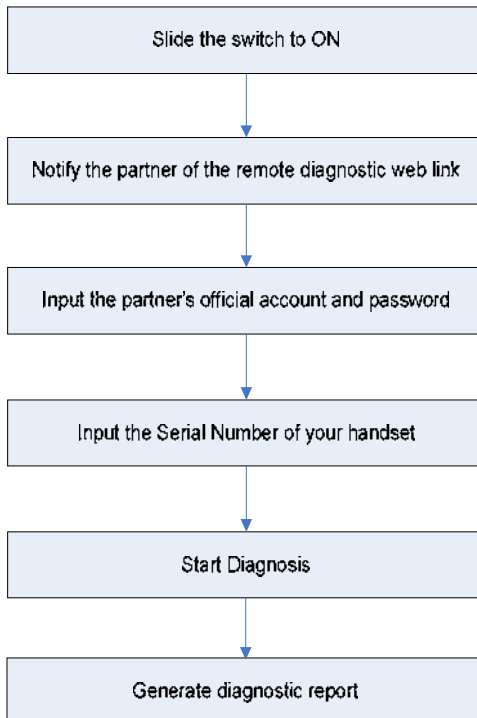

Tap the **Remote** tab, the following screen will appear:

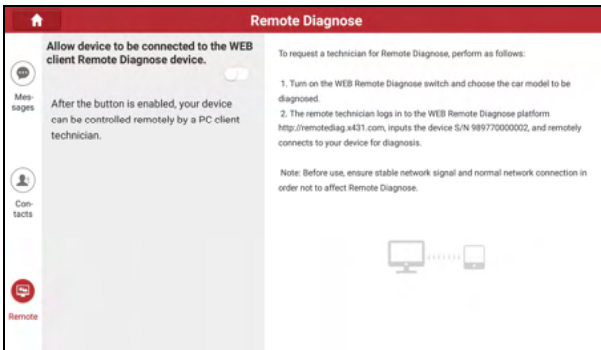

1. Slide the switch “Allow device to be connected to the WEB client remote diagnostic device” to ON so that the partner can find and access to this device while using the PC.
2. Notify the partner of the PC client website <http://remote.x431.com>. When the partner opens the link, the PC displays as below:

*Note: Before processing remote diagnosis, please make sure the VCI device is properly connected to the vehicle.

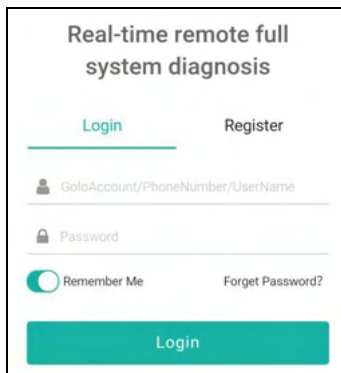

3. Tell the partner to input his own official technician account and password, and then tap **Login** to navigate to the following figure.

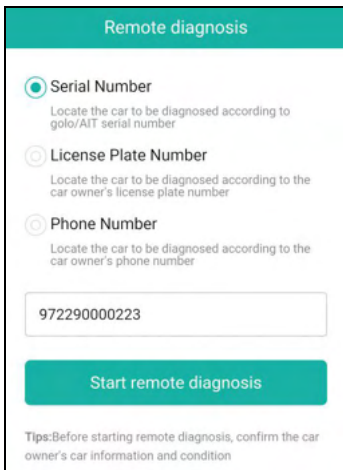

4. Tell the partner to check the box “Serial number” and enter the Serial Number provided by you, and then tap **Start remote diagnosis**.
5. A popup displays to ask for your confirmation to allow remote control on your device.
6. Tap **Allow** to accept, or tap **Deny** to reject.

In process of remote diagnosis, please note the following things:

- 1) You are not suggested to execute any actions.
- 2) The partner is not allowed to save any diagnostic reports or records on your tablet.

The operations in remote diagnosis are same as those in local diagnosis. Once the session is complete, a remote diagnostic report will be automatically generated.

5.4 Manage Reports

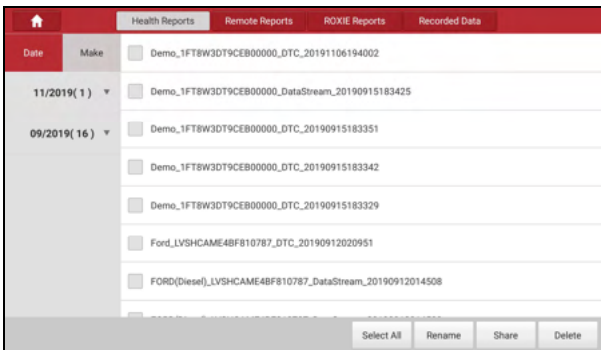

5.4.1 Health reports

This module stores all diagnostic reports generated in process of vehicle diagnosis.

All diagnostic reports are sorted by Date and Make. Tap the desired type to re-arrange and filter it.

- To select certain report, check the box before the report. To select all reports, tap **Select All**. To deselect all, tap **Unselect**.
- To revise the filename of the report, select the desired one and tap **Rename**.
- To share the report with others, select the desired one and then tap **Share**.
- Select the desired report and then tap **Delete** to delete it.

5.4.2 Remote reports

This option lists all diagnostic reports generated in process of remote diagnostics.

5.4.3 ROXIE reports

This option stores all vehicle inspection reports generated by the ROXIE W device that has been bound to the tool.

5.4.4 Recorded data

If user records the running parameters or waveform graphs while reading data stream, it will be saved as diagnostic records and appear under this tab.

Tap **Recorded Data**, and select certain diagnostic record to enter.

Select the desired data stream items and tap **OK** to navigate to the playback page.

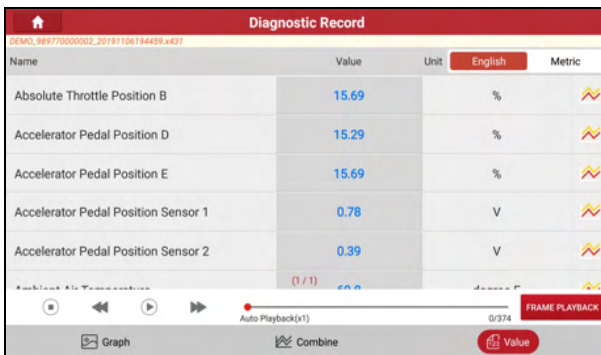

On-screen Buttons:

Graph – displays the parameters in waveform graphs.

Combine – this option is mostly used in graph merge status for data comparison. In this case, different items are marked in different colors.

Value – this is the default mode which displays the parameters in texts and shows in list format.

Frame Playback – plays back the recorded data stream items frame by frame. Once it is

in frame playback mode, this button changes into **Auto Playback**.

5.5 I/M Readiness

An important part of a vehicle's OBD II system is the Readiness Monitors, which are indicators used to find out if all of the emissions components have been evaluated by the OBD II system. They are running periodic tests on specific systems and components to ensure that they are performing within allowable limits.

Currently, there are eleven OBD II Readiness Monitors (or I/M Monitors) defined by the U.S. Environmental Protection Agency (EPA). Not all monitors are supported in every vehicle and the exact number of monitors in any vehicle depends on the motor vehicle manufacturer's emissions control strategy.

Continuous Monitors -- Some of the vehicle components or systems are continuously tested by the vehicle's OBD II system, while others are tested only under specific vehicle operating conditions. The continuously monitored components listed below are always ready:

- 1) Misfire
- 2) Fuel System
- 3) Comprehensive Components (CCM)

Once the vehicle is running, the OBD II system is continuously checking the above components, monitoring key engine sensors, watching for engine misfire, and monitoring fuel demands.

Non-Continuous Monitors -- Unlike the continuous monitors, many emissions and engine system components require the vehicle to be operated under specific conditions before the monitor is ready. These monitors are termed non-continuous monitors and are listed below:

- 1) EGR System
- 2) O2 Sensors
- 3) Catalyst
- 4) Evaporative System
- 5) O2 Sensor Heater
- 6) Secondary air Injection
- 7) Heated Catalyst
- 8) A/C system

I/M refers to Inspection and Maintenance that is legislated by the Government to meet federal clean-air standards. I/M Readiness indicates whether or not the various emissions-related systems on the vehicle are operating properly and are ready for Inspection and Maintenance testing.

The purpose of the I/M Readiness Monitor Status is to indicate which of the vehicle's

Monitors have run and completed their diagnosis and testing, and which ones have not yet run and completed testing and diagnosis of their designated sections of the vehicle's emissions system.

The I/M Readiness Monitor Status function also can be used (after repair of a fault has been performed) to confirm that the repair has been performed correctly, and/or to check for Monitor Run Status.

Tap **I/M Readiness** on the Diagnostics function selection screen to start checking. After checking all I/M readiness status, the screen will output the result:

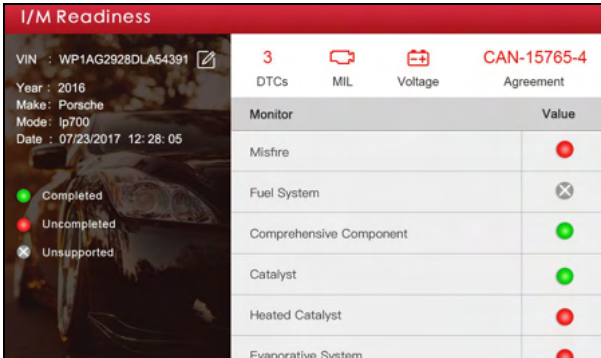

*Note: ⊗ means not available on this vehicle, ● means incomplete or not ready, ● means Completed or Monitor Ok.

5.6 How to View Diagnostic History?

Generally once a vehicle diagnosis is performed, the tablet will record the every details of diagnostic process. The History function provides direct access to the previously tested vehicles and users can resume from the last operation, without starting from scratch.

Tap **History** on the Diagnostics function selection screen, all diagnostic records will be listed on the screen in date sequence.

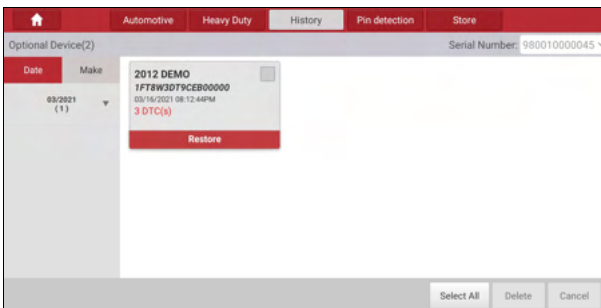

- Tap certain vehicle model to view the details of the last diagnostic report.

- To delete certain diagnostic history, select it and then tap **Delete**. To delete all historical records, tap **Select All** and then tap **Delete**.
- Tap **Restore** to directly navigate to the function selection page of last diagnostic operation. Choose the desired option to proceed.

5.7 Diagnostic Feedback

This item allows you to feedback your diagnostic problems to us for analysis and troubleshooting.

Tap **Diag. Feedback** on the Diagnostics function selection screen, the following 3 options will be displayed on the left column of the screen.

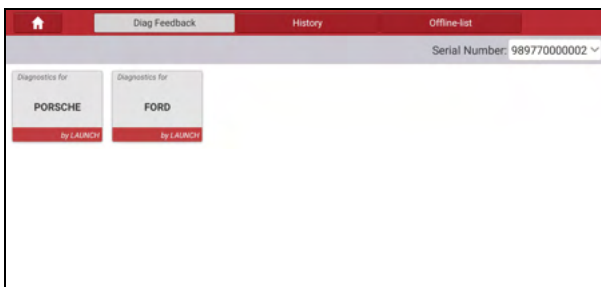

A. Diag. Feedback

Tap a tested vehicle model to enter the feedback screen.

- 1) Tap **Choose File** to open the target folder and choose the desired diagnostic logs.
- 2) Choose the failure type and fill in the detailed failure description in the blank text box and telephone or email address. After inputting, tap **Submit Result** to send it to us.

B. History

Tap it to view all diagnostic feedback records. Different process states are marked with different colors.

C. Offline list

Tap it to display all diagnostic feedback logs which have not been submitted successfully due to network failure. Once the tablet gets a stable network signal, it will be uploaded to the remote server automatically.

5.8 Repair Info

This feature provides a quick dial to some authoritative official automotive repair websites for your reference and retrieval. Meanwhile, it also allows you to add some frequently used websites into Favorites so that you can quickly access them in future.

Tap the desired website to visit it.

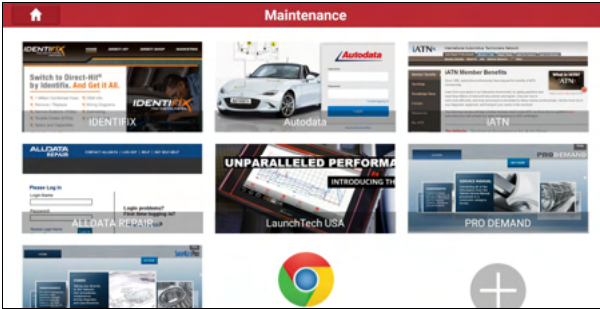

To add certain website into favorites, scroll the screen to until it reaches to the bottom, tap **+**, the following dialog box will appear.

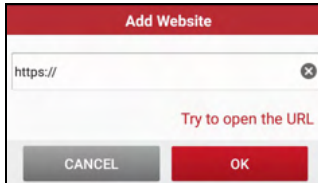

Type in the full web site in the blank, and tap **OK**, it will be listed in the Favorites.

6 Software Update

This module allows you to update the diagnostic App and frequently used software.

6.1 Update Diagnostic Software & APP

Go to **Software Update** on the Diagnostics function selection screen and tap the **Downloaded** tab.

The **Available** tab displays a list of software that can be updated. Under it, all software is categorized into three kinds:

- **Common software:** mainly includes some common apps that are associated with the diagnostic app. The software of this kind always stays at the top of the list, which can be deselected manually (excluding the system app, such as firmware and ECU aid).
 - **Frequently used vehicle software:** refers to the diagnostic software that is frequently used, including the vehicle diagnostic software and Reset software. It is generally displayed following the **Common software** list.
 - **Other vehicle software:** refers to the diagnostic software that is rarely used or never used. It is generally displayed following the **Frequently used software** list.
- 1). If the user does not download any diagnostic software during the sign-up process, all diagnostic software is selected by default. Tap **Update** to start downloading.
 - 2). If the user downloaded all/some vehicle software during the sign-up process and had it serviced for a long period of time, only the frequently used software is selected. Tap **Update** to start downloading. Other vehicle software that is rarely used will also be listed under the Available tab, but it is not selected at default.

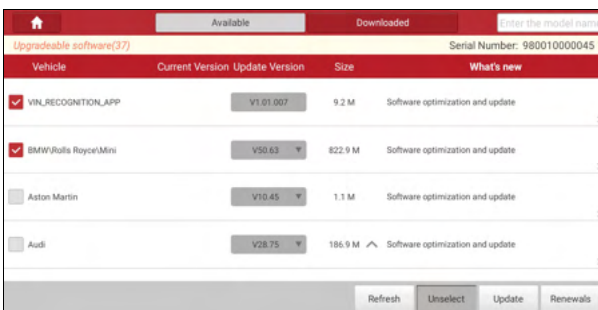

Once download is finished, the software packages will be installed automatically.

To download certain software that is not frequently used, check the box before the vehicle model. Tap **Update** to start downloading.

Once download is finished, the software packages will be installed automatically.

6.2 Update Frequently Used Software

If the user only intends to update the frequently used software, go to **Software Update** and tap the **Downloaded** tab.

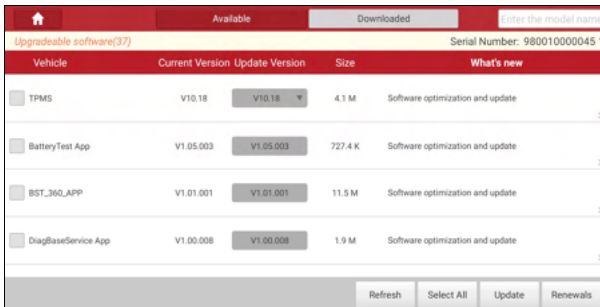

Tap **Update** to start downloading. Once download is finished, the software packages will be installed automatically.

6.3 Renew Software Subscription

If the software subscription is due or expires, the system will prompt you to renew your subscription.

Tap **Renewal** to navigate to the Store screen.

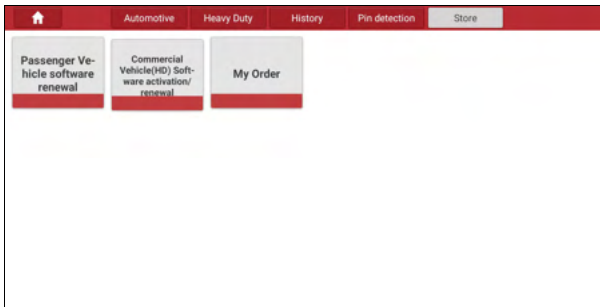

Tap the desired software renewal package, the following screen will appear:

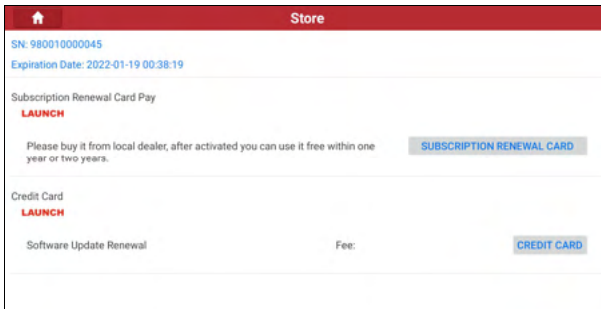

There are two ways available for you to make payment: Subscription Renewal Card (*need to buy it from the local dealer where you purchased the tool) and Credit Card.

A. Using Subscription Renewal Card

1. Select **Subscription Renewal Card**.
2. Input the 24-digit pin code of Subscription Renewal Card and then tap **Submit** to finish the renewal.
3. Go to update center to update the diagnostic software.

B. Credit Card

1. Select **Credit Card**, and then follow the on-screen instructions to finish the transaction.
2. After payment, go to update center to update the diagnostic software.

7 Settings

This function allows users to make some app settings, such as units, expiration reminder and VCI management etc.

7.1 General

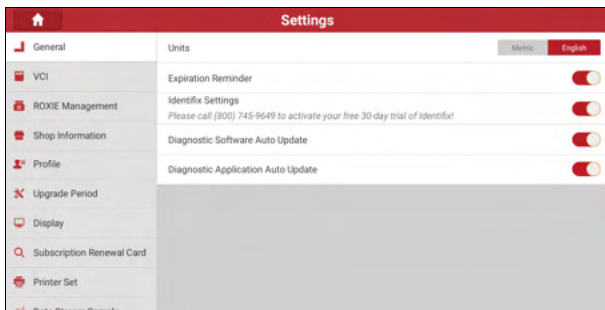

7.1.1 Units

It is designed to set the measurement unit. Metric System and English System are available.

7.1.2 Expiration reminder

All pre-installed diagnostic software is free to use for 30 days. Once it expires, it will be locked automatically and the system will prompt you to activate your dongle if the expiration reminder is ON.

7.1.3 Identifix settings

This option is used to set whether the free 30-day trial Identifix shows or not.

7.1.4 Diagnostic software auto update

This option is designed to turn on/off the automatic diagnostic software update function. If set as ON, the system will automatically update the available diagnostic software when the tablet has a network connection and a newer version is detected.

7.1.5 Diagnostic application auto update

This option is used to set whether to update the available diagnostic application automatically when the tablet has stable Wi-Fi signal.

7.2 VCI

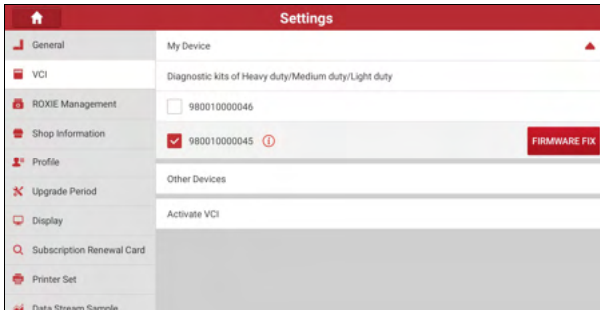

If several VCI devices are activated on this tool, a list of VCI devices will be displayed on the screen.

Once you choose the device that belongs to other account, you have to log out, and then input the right account to continue.

- If the current VCI comes across communication failure, tap **Firmware Fix** to update and fix the diagnostic firmware. During fixing, please do not cut power or switch to other interfaces.
- If you skipped the Activate VCI step in process of sign-up, tap **Activate VCI** to activate it.

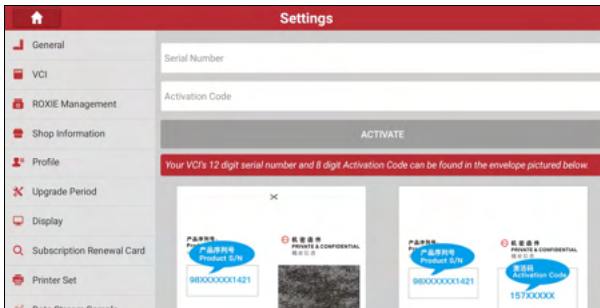

Input the Serial Number and Activation Code (can be found from the included Password Envelope), and then tap **Activate** to activate it.

*Note: please be sure to keep the VCI device powered on while performing the operation.

7.3 ROXIE Management

This option is used to activate and bind the ROXIE W device to the tool. Once bound, the reports generated by the ROXIE W device will be automatically pushed to the tool each time the inspection session is finished.

Tap **ROXIE Management**, the following screen will appear:

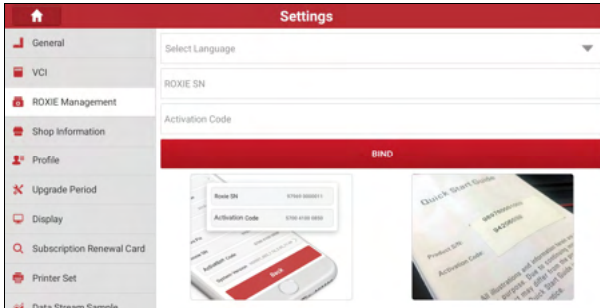

Fill in the ROXIE W S/N and Activation Code (can be found in the Settings on the Job Menu), then tap **BIND**.

7.4 Shop Information

This option lets you define your print information. It mainly includes Workshop, Address, Zip Code, Telephone, Email etc.

After inputting, tap **Save**. Once you saved the print information, it will be entered automatically in the “More Information” box every time you save the diagnostic report.

7.5 Profile

Use this item to view and configure personal information.

7.6 Upgrade Period

This option allows you to check the expiry date of all downloaded software.

7.7 Display

7.7.1 Icon size

This feature allows you to set the size of the diagnostic software icon according to your preference.

Drag the slider to different size and the system will display the corresponding effect.

7.7.2 Color theme

This item enables you to set the color theme of the App.

Once you changed it, you have to reboot the system for the change to take effect.

7.8 Subscription Renewal Card

If you renew your subscription with the subscription renewal card, use this option to check the status of the renewal card.

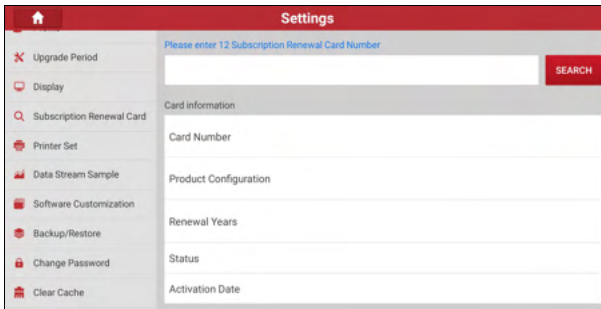

Enter the 12-digit subscription renewal card number, and tap **SEARCH** to check the status. It mainly includes the product configuration, renewal years and activation date etc.

7.9 Printer Set

This option is used to establish a wireless connection between the tablet and the printer (sold separately) while performing printing operations.

The App is compatible with the “LAUNCH Wi-Fi Printer” (sold separately) and “System” (external printer).

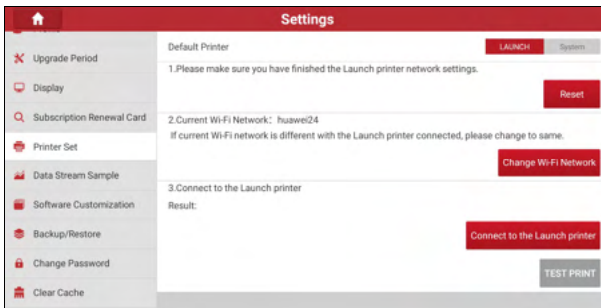

For LAUNCH Wi-Fi mini printer, follow the steps below to connect the printer.

1. Tap **Printer Set**.

A. If it is the first time you have operated this printer, please proceed the following:

1. For initial use, you are suggested to reset the printer: Press and hold [MODE] & [FEED] for 8 seconds, the following resetting command will be printed out:

at + default = 1

ok

at + reboot = 1

rebooting...

2. Tap **Reset** to configure Wi-Fi printer.

Step 1: Connect the printer:

Tap **Scan** to start scanning and select the desired printer hotspot named with X-431PRINTER-XXXX (XXXX stands for 4 characters), and then tap **Connect** to enter Step 2.

Step 2: Join the Wi-Fi printer into LAN:

Tap **Scan** to select the desired local Wi-Fi network from the list, and type in the security password (If it is an open network, password is not required), and then tap **Confirm**.

- Once the Wi-Fi network of the printer is connected and the printer is found, tap **Printing test** to test the printing.

Now the Wi-Fi printer is ready for printing.

If the printer is not found, please reset the printer to default factory settings (refer to Step 2 for details) and check whether the current device and the printer are on the same LAN.

B. If you have configured the Wi-Fi printer to the LAN:2. Tap **Connect to Printer:**

- If the local network remains as it is, tap **Test Print** directly to test the printing.
- If the local network changes, you have to reset the Wi-Fi printer.

For other Wi-Fi printers.

Before printing, make sure the following conditions are met:

- The Wi-Fi printer is powered on and working normally.
- The print service plug-in associated with the printer is already installed on the tablet (Go to Google Play or use the Browser to download and install it).

Follow the steps below to proceed:

- Set the default printer as **System**.
- Go to **Settings -> Network & Internet -> WLAN**, set the WLAN switch to Off.
- On the report details page, tap .

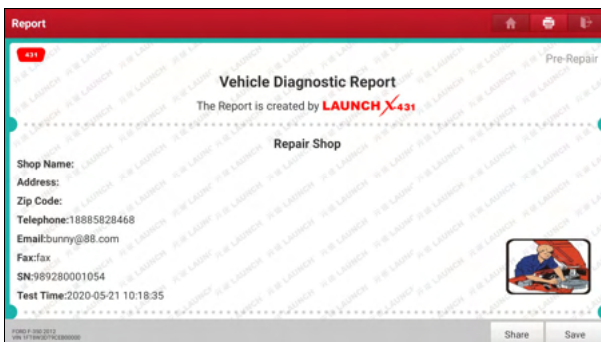

4. Touch  next to **Select a printer** on the upper left corner of the screen.

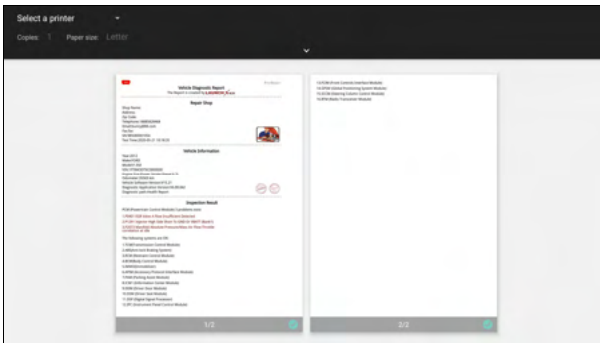

5. Select **All Printers** -> **Add printer** and enable the installed printer service, the system starts searching for all available Wi-Fi printers of the brand.

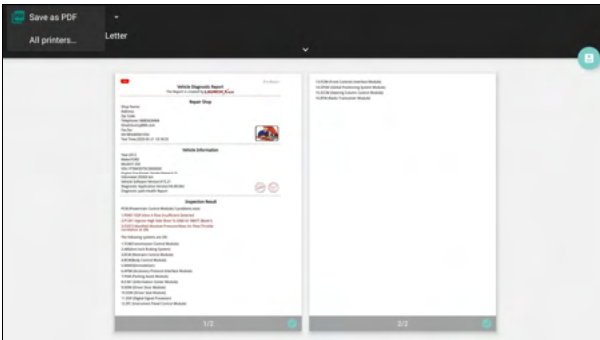

6. Select the desired Wi-Fi printer from the list. If the chosen Wi-Fi printer hotspot is open, the tablet can connect it directly. If it is encrypted, a password may be required. Refer to the Wi-Fi printer user manual to get the default password.
7. Now the printer is ready for printing.
8. Alternatively, you can also choose **Save as PDF** to save the current diagnostic report as a PDF file for later printing.

7.10 Data Stream Sample

This feature allows you to manage the recorded data stream sample files.

7.11 Software Customization

This item allows you to hide/clear the diagnostic software that is not frequently used.

Tap **Software Customization**, the following screen will appear:

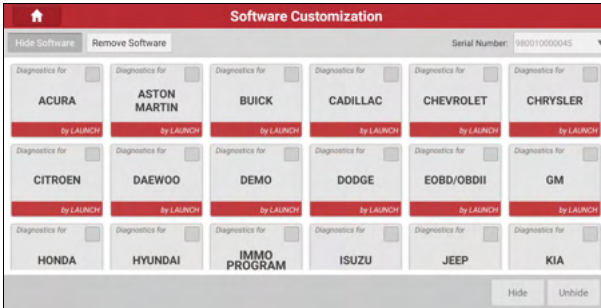

Under the **Hide Software** tab, select the desired diagnostic software and tap **Hide**, it will become invisible. Tap **Unhide** to undo the hide operation.

Under the **Remove Software** tab, select the desired diagnostic software and tap **Delete**, it will disappear from the screen.

*Note: Removing software may completely delete the software from the tablet. If some software is not used and the tablet runs out of space, you can use this feature to remove it. To re-download it, go to **Software Update -> Available**.

7.12 Backup/Restore

This option lets you backup/restore the important data to/from external storage device.

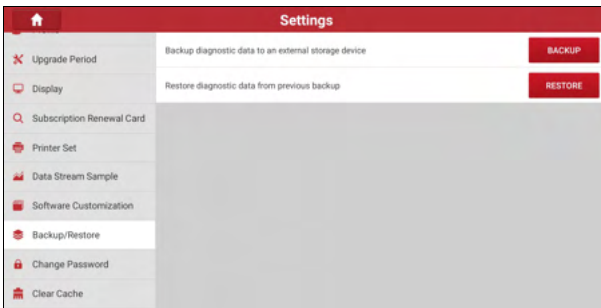

A. Backup

- 1). Insert the U disk into the Data Transmission Port of the tablet.
- 2). Tap **Backup** to select the data folder to be backed up.
- 3). Tap **Backup** on the bottom of the screen to copy it to the U disk.
- 4). Unplug the U disk from the tablet.

B. Restore

- 1). Insert the U disk into the Data Transmission Port of the tablet.
- 2). Tap **Restore** to select the data folder to be restored.
- 3). Tap **Restore** on the bottom of the screen to copy it to the tablet.

4). Unplug the U disk from the tablet.

7.13 Change Password

This item allows you to modify your login password.

7.14 Clear Cache

This item is used to clear the App cache.

Tap **Clear Cache**, a pop-up window will appear on the screen. Tap **OK** to clear cache and the system will restart the App.

7.15 About

The software version information and disclaimer are included.

7.16 Log Out

To logout the current user ID, tap **Log Out**.

To login the system again, tap **Login**.

8 Toolbox

8.1 TPMS

This module allows you to configure the tablet as TPMS activation & diagnostic tool, which provides the ability to trigger TPMS sensor, program TPMS sensor, perform the relearning procedure. It needs to work with the X-431 TSGUN device (sold separately).

Below illustrates how the tablet works with the X-431 TSGUN.

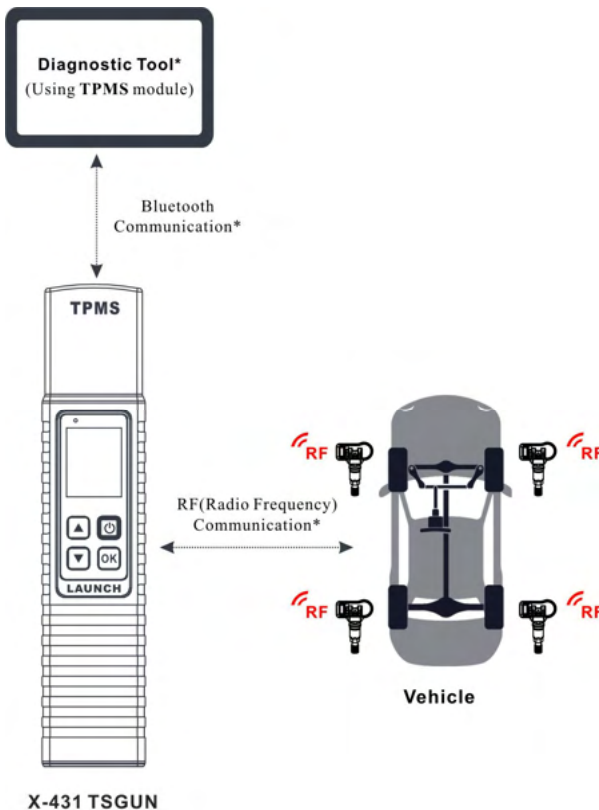

For more details, refer to the User Manual included with the X-431 TSGUN.

8.2 ADAS

Advanced Driver Assistance Systems (ADAS) are electronic components in vehicles, which include a wide range of safety features for vehicles such as autonomous emergency braking (AEB), lane departure warning (LDW), lane keep assist, blind spot

elimination, night vision cameras and adaptive lighting.

The cameras and sensors used by these systems have to be precisely calibrated and adjusted. Incorrect calibration resulting from windscreen replacement or wheel alignment can cause the system to deliver incorrect results or even fail completely, resulting in a serious accident or even a fatality.

The ADAS feature on this diagnostic tool is disabled by default and user needs to activate this feature with the Activation Code (optional) before performing this function. Moreover, it also requires the diagnostic tool to work with the ADAS calibration tool manufactured by LAUNCH (calibration tools from other manufacturers will not be supported). As a comprehensive and flexible calibration tool, the ADAS calibration tool enables you to effectively and accurately calibrate a wide range of camera-based & radar-based driver assistance systems, e.g. the front camera for the lane departure warning system, the radar sensor for the ACC (Adaptive Cruise Control) or the camera for adaptive headlights. Follow the steps below to activate it.

1. Tap **ADAS** on the Toolbox function selection screen.

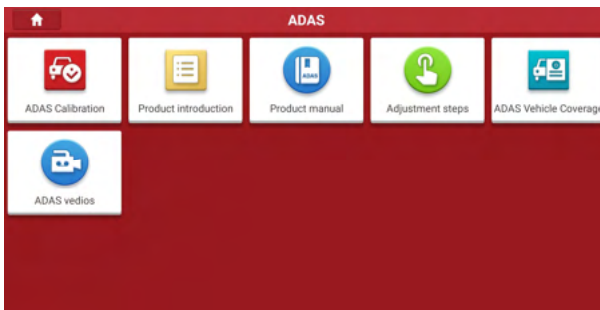

The following functions are included in this module:

- **ADAS Calibration:** This option allows you to activate the ADAS function on this tool.
 - **Product Introduction:** A brief introduction of the ADAS calibration tool.
 - **Product Manual:** The user manual of the ADAS calibration tool is available for easy retrieval and reference.
 - **Adjustment Steps:** The detailed adjustment steps on how to calibrate the ADAS calibration tool.
 - **ADAS Vehicle Coverage:** Checks all vehicle models that the ADAS calibration tool covers.
 - **ADAS Videos:** Collects some tutorial videos on how to make ADAS calibrations.
2. Tap **ADAS Calibration**.

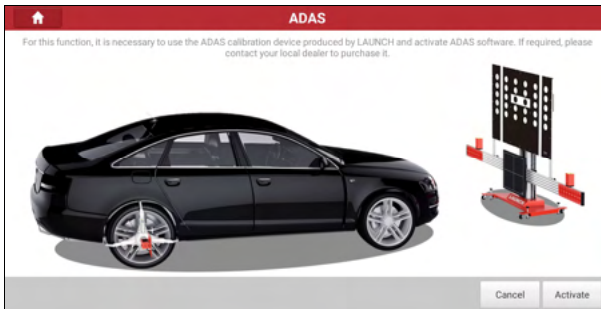

3. Tap **Activate** to enter the ADAS activation screen.

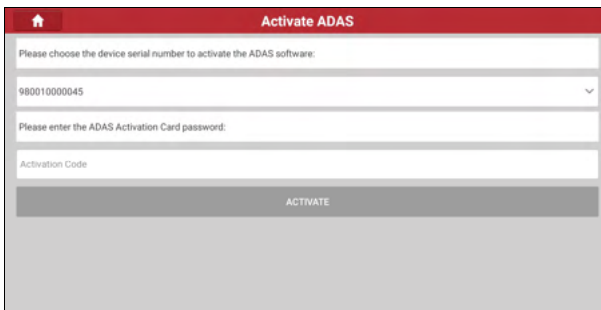

4. Scratch or scrap the designated area on the Activation Card to reveal the password, and input the 24-digit password to activate it.

For more details, refer to the User Manual included with the ADAS Calibration Tool.

8.3 Videoscope

This tool provides an optional function of Videoscope (needs to be purchased separately).

Automotive videoscope is mainly applied to those unseen parts of engine, fuel tank, braking system.

While testing a vehicle system, engine is one of the main parts to be checked. To check if the internal of an engine is qualified or not or whether internal carbon deposit and damage exists in the engine or not, we can make full use of a videoscope to solve these questions.

For more details, refer to the User Manual included with the Videoscope.

8.4 Oscilloscope

This tool provides an optional function of Oscilloscope (needs to be purchased separately). It mainly includes automotive oscilloscope and automotive ignition waveform.

Automotive oscilloscope can make the auto repair technician quickly judge the faults on

automotive electronic equipment and wiring, and the oscilloscope sweep speed is far greater than the signal frequency of such vehicles, usually 5-10 times of the measured signal. The automotive oscilloscope not only can quickly acquire the circuit signal, but also can slowly display the waveform to observe and analyze. It can also record and store the tested signal waveform which can be recalled to observe for the fast signal, having great convenience to failure analysis. Either high-speed signal (e.g.: Injection nozzle, intermittent fault signal) or the slow-speed signal (e.g. the throttle position change and the oxygen sensor signal) can be observed through automotive oscilloscope in an appropriate waveform.

For more details, refer to the User Manual included with the Oscilloscope.

8.5 Ignition Scope

This tool provides an optional function of Ignition Analysis. It can test and analyze the secondary signal for various engine ignition systems.

The ignition system is the system which has greatest impact on the performances of gasoline engine, as the statistical data shows that nearly half of the failures are caused by poor work of electrical system. And the performance tests of engine often start from the ignition system. Nowadays ignition system includes distributor and distributorless. Distributorless includes independent ignition and simultaneous ignition.

The function uses the same hardware device as the Oscilloscope module.

For more details, refer to the User Manual included with the Oscilloscope.

8.6 Sensor Simulator

This tool provides an optional function of Sensor Simulator (needs to be purchased separately). It is specially developed for diagnosing/simulating sensor faults.

The sensors are the signal input devices of the vehicle ECU. It converts vehicle operating parameters such as vehicle speed, coolant temperature, engine speed, air flow, and throttle opening into electrical signals and sends them to the vehicle ECU. Then, the vehicle ECU adjusts the engine running status to maintain the engine in optimal condition.

For more details, refer to the User Manual included with the Sensorbox.

8.7 Multimeter

This tool provides an optional function of Multimeter (needs to be purchased separately).

The function uses the same hardware device as the Sensor Simulator module.

Through this function, users can test voltage, resistance, and capacitance..

For more details, refer to the User Manual included with the Sensorbox.

8.8 Battery Tester

The tool provides an optional function of automotive battery test (needs to be purchased separately). It supports various battery standards and specifications, including CCA, DIN, IEC, EN, JIS, SAE and GB etc.

It is specifically designed to help car owner, repair workshop, battery factory use battery test instrument properly and determine whether the battery is normal or not.

For more details, refer to the User Manual included with the Battery Tester.

9 Others

This module provides a quick access to some frequently used system applications. Swipe the screen from the right to “Others” module, the following screen will appear:

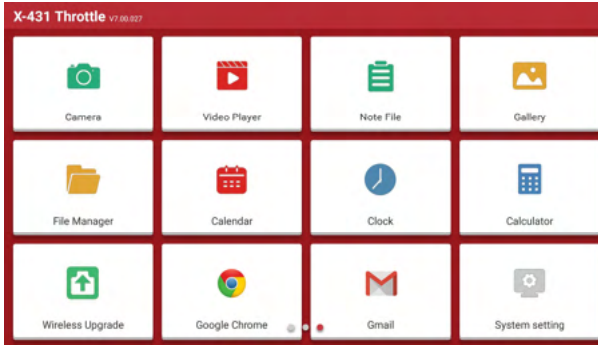

9.1 Wireless Upgrade

An Over-the-Air (OTA) update is the wireless delivery of new operating system, software or data to tablets and mobile phones. Wireless carriers have traditionally used over-the-air updates to deploy firmware and configure phones or tablets for use on their network. The initialization of a newly purchased tablet required an over-the-air update.

*Note: While performing OTA update, please make sure the tablet battery has at least 70% and DO NOT run any other programs during the update.

1. Tap **Wireless Upgrade**.

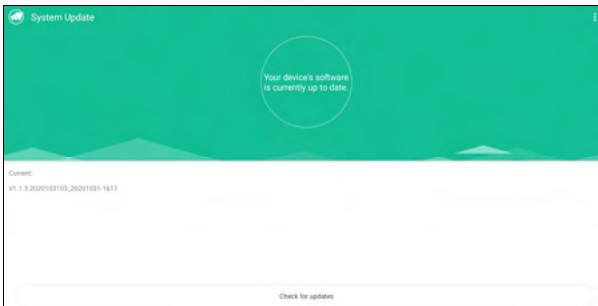

2. Tap **Check for updates**. Once a newer version is found, follow the on-screen instructions to download and install the update file.
3. Be patient to wait until the update is done.

9.2 File Manager

ES File Explorer is a file and application manager. You can access and create folders on the tablet without needing to connect it to a computer.

The app also features an application manager, task killer and download manager. Another excellent feature is support for cloud storage accounts. This means you can download files directly to the folders you want without using a separate app.

The app has built-in ZIP and RAR sources, so you can access compressed files without unpacking them on your computer first.

For more information, please refer to the associated ES file explorer documents.

You can transfer media files, screenshots and APK between the PC and tablet.

1. On the Home screen, go to **System -> USB Management**, turn off the USB switch to activate the Type C interface.

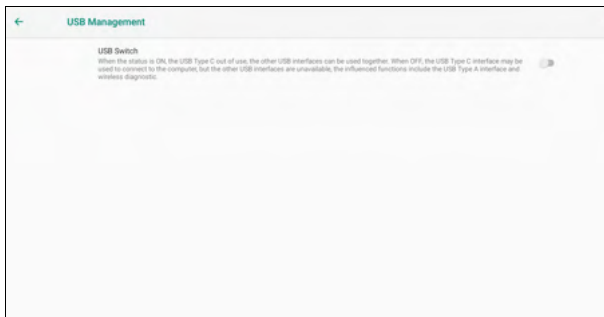

2. Connect one end of the included data cable to the Type C port of the tablet, and the other end to the USB port of the PC.
3. Swipe the tablet screen from the top, a pull-down option list will appear on the screen.



4. Tap Android System, the following setting options will be displayed on the screen.

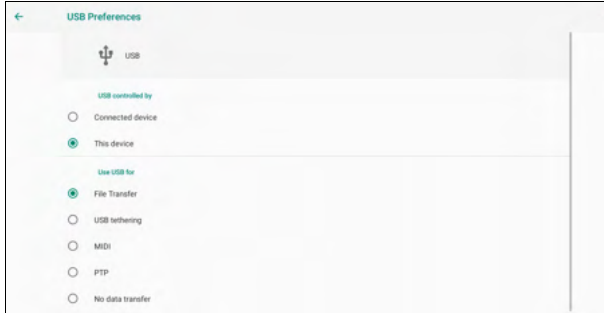

5. Select the checkbox **File Transfer** under the **Use USB for** tab.
6. Now you can transfer files between the tablet and PC.

9.3 System Setting

This module provides a quick dial to the Android's system settings. Alternatively, it also can be accessed by tapping the Settings on the Android home screen.

10 J2534 Reprogramming Using SmartLink

Flash programming has become a common and profitable procedure in the repair and service of today's vehicles. As part of the 21st Century Tune-up, reprogramming is often the only solution for problems ranging from driveability and loss of power to poor fuel economy and emissions related issues. SmartLink makes it easy. The SmartLink is a communication interface designed to support J2534 specifications for ECU reprogramming.

10.1 As a Local J2534 PassThru Device

Except that the SmartLink acts as a VCI device, it also can be used as a J2534 PassThru device, working together with the PC installed with the OEM diagnostic software to perform the J2534 reprogramming. In this case, the PC needs to install with the LAUNCH's J2534 tool, which can be downloaded from www.cnlaunch.com.

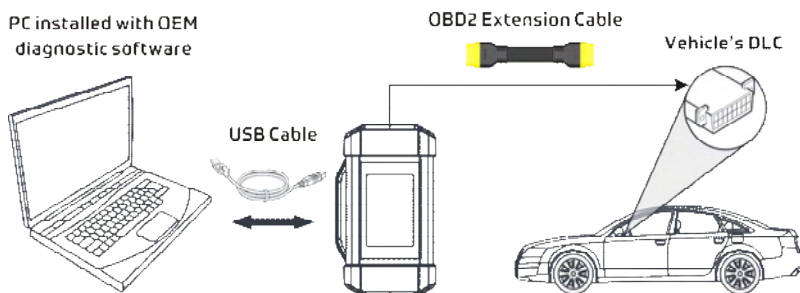

10.2 As a Remote J2534 PassThru Device

Besides local ECU reprogramming, remote ECU reprogramming function is also supported using SmartLink.

*Note: Before diagnosing, please make sure the following conditions are met:

- The SmartLink device is connected to the Internet and has a strong network signal.
- The OEM diagnostic software has been installed on the PC.
- The LAUNCH's J2534 tool also needs to be installed on the PC. This tool and its associated operation instruction documentation can be downloaded from www.cnlaunch.com.

Ensure that the remote reprogramming operation is performed after the SmartLink is connected to the vehicle's DLC port and the Internet, and has been switched to the super remote diagnosis mode. For specific operations, please refer to other associated documentation.

PC installed with OEM
diagnostic software

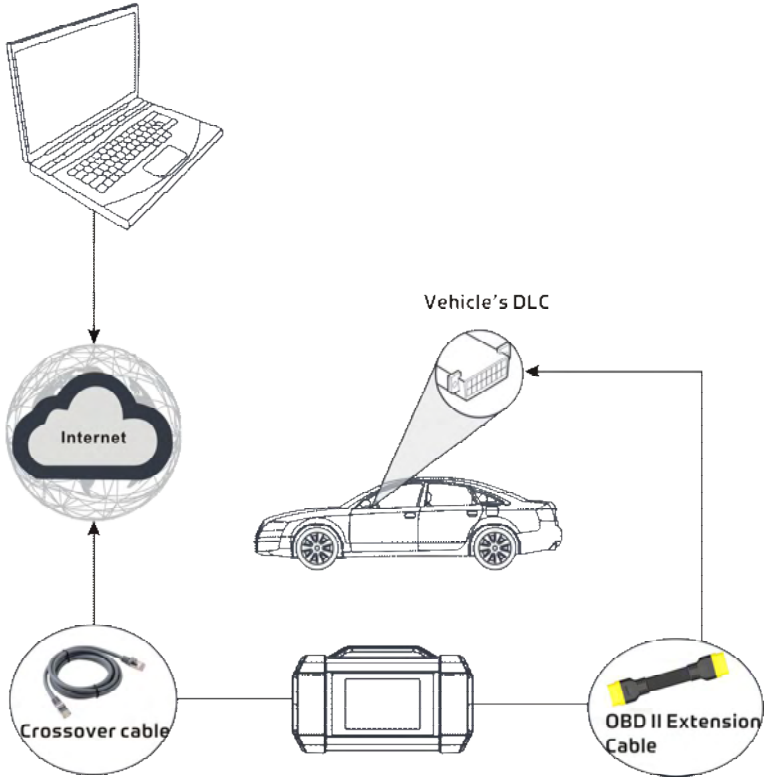

11 FAQ

1. Communication error with vehicle ECU?

Please confirm:

- 1) Whether the VCI is properly connected.
- 2) Whether the vehicle ignition switch is ON.
- 3) If all checks are normal, send vehicle year, make, model and VIN number to us using Diagnostic Feedback feature.

2. Failed to enter into vehicle ECU system?

Please confirm:

- 1) Whether the vehicle is equipped with the system.
- 2) Whether the VCI is correctly connected.
- 3) Whether the vehicle ignition switch is ON.
- 4) If all checks are normal, send vehicle year, make, model and VIN number to us using Diagnostic Feedback feature.

3. Can I use any other power adaptor other than the included power adaptor to charge the tablet?

No. Please use only the included power adaptor to charge the tablet. We assume no responsibility for damage or loss resulting from the use of the any other adaptors.

4. How to save power?

- Please turn off the screen while the tablet keeps idle.
- Set a shorter standby time.
- Decrease the brightness of the screen.
- If WLAN connection is not required, please turn it off.
- Disable GPS function if GPS service is not in use.

5. What to do if the language of vehicle diagnostic software does not match the system language?

English is the default system language of the tool. After the system language is set to the preference language, please go to the update center to download the vehicle diagnostic software of the corresponding language.

If the downloaded diagnostic software is still displayed in English, it indicates that the software of the current language is under development.

6. How to retrieve the login password?

Please follow below steps to proceed in case you forgot the login password:

1. Tap the application icon on the home screen to launch it.
2. Tap the **Login** button on the upper right corner of the screen.
3. Tap **Retrieve password**.
4. Input product S/N and follow the on-screen prompts to retrieve the password.

7. The diagnostic application is failing.

1. Tap the Home key on the tool.
2. Select **Settings -> Apps & notification**.
3. Select the application name from the Apps list.
4. Select **Force Stop**, and then press **OK** to confirm.
5. Select **Clear Data**, and then press **OK** to confirm.

12 Glossary of Terms & Abbreviations

ABS – Anti-Lock Brake System

AC – Alternative Current

ADAS -- Advanced Driver Assistance Systems

AFS – Adaptive Front-lighting System

CAN – Controller Area Network

Communication Protocol – Allows different systems and sensors in a vehicle to communicate.

There are currently five Protocols:

- CAN Bus
- J1850 VPW
- ISO 9141-2
- J1850 PWM
- ISO 14230 KWP

DC – Direct Current

DLC – Data Link Connector

The 16-cavity connector on the vehicle that allows communication between the computer system and the diagnostic tool.

DPF – Diesel Particulate Filter

DTC – Diagnostic Trouble Code

A code stored in the computer system's memory, which helps to identify the fault condition that is causing the MIL to activate.

Drive Cycle – A set of driving procedures that, when met, provide the Enabling Criteria for the I/M Monitors to run and complete their diagnostic tests.

Freeze Frame Data – A digital representation of engine and/or emissions system conditions present when a fault code was recorded.

Generic Code – A DTC that applies to all OBD2 compliant vehicles.

I/M – Instant Messaging

I/M Readiness – An indication of whether or not a vehicle's emissions-related system are operating properly and are ready for Inspection and Maintenance testing.

LCD – Liquid Crystal Display

LED – Light Emitting Diode

Manufacturer Specific Code – A DTC that applies only to OBD II-compliant vehicles

made by a specific manufacturer.

MIL – Malfunction Indicator Lamp

The vehicle's "Check Engine" warning light that activates when a DTC is stored.

OBD I – On-Board Diagnostics Version 1

OBD II – On-Board Diagnostics Version 2

OEM – Original Equipment Manufacturer

PID – Parameter Identification Data

Data returned by the vehicle's Control Modules to the diagnostic tool.

TPMS – Tire Pressure Monitor System

VCI – Vehicle Communication Interface

WLAN – *Wireless Local Area Network*

Warranty

THIS WARRANTY IS EXPRESSLY LIMITED TO PERSONS WHO PURCHASE LAUNCH PRODUCTS FOR PURPOSES OF RESALE OR USE IN THE ORDINARY COURSE OF THE BUYER'S BUSINESS.

LAUNCH electronic product is warranted against defects in materials and workmanship for one year from date of delivery to the user.

This warranty does not cover any part that has been abused, altered, used for a purpose other than for which it was intended, or used in a manner inconsistent with instructions regarding use. The exclusive remedy for any automotive meter found to be defective is repair or replacement, and LAUNCH shall not be liable for any consequential or incidental damages.

Final determination of defects shall be made by LAUNCH in accordance with procedures established by LAUNCH. No agent, employee, or representative of LAUNCH has any authority to bind LAUNCH to any affirmation, representation, or warranty concerning LAUNCH automotive meters, except as stated herein.

Disclaimer

The above warranty is in lieu of any other warranty, expressed or implied, including any warranty of merchantability or fitness for a particular purpose.

Purchase Order

Replaceable and optional parts can be ordered directly from your LAUNCH authorized tool supplier. Your order should include the following information:

- Order quantity
- Part number
- Part name

Customer Service

If you have any questions or comments please forward them to:

LAUNCH Tech USA**Product Support**

Phone: 877-528-6249 xt: 4

E-mail: support@launchtechusa.com

Fax: 562-463-1590

Monday - Friday 5 am - 5 pm PST

Service & Repair

Phone: 877-528-6249 xt: 5

Monday - Friday 8 am - 5 pm PST

If your unit requires repair service, return it to the manufacturer with a copy of the sales receipt and a note describing the problem. If the unit is determined to be in warranty, it will be repaired or replaced at no charge. If the unit is determined to be out of warranty, it will be repaired for a nominal service charge plus return freight. Send the unit pre-paid to:

Attn: LAUNCH Tech USA
1820 South Milliken Ave.
Ontario, CA 91761